

Electric Actuators with Process Controllers

TROVIS 5724-3 (without fail-safe action)

TROVIS 5725-3 (with fail-safe action)



for domestic hot water heating



Mounting and Operating Instructions

EB 5724 EN

Firmware version 2.1x

Edition November 2014



Definition of signal words



DANGER!

Hazardous situations which, if not avoided, will result in death or serious injury



WARNING!

Hazardous situations which, if not avoided, could result in death or serious injury



NOTICE

Property damage message or malfunction



Note:

Additional information



Tip:

Recommended action

1	General safety instructions	5
2	Design and principle of operation	6
2.1	Accessories	8
2.2	Technical data	8
2.3	LED blinking pattern	10
3	Attachment to the valve	11
3.1	TROVIS 5724-3	11
3.1.1	Force-locking attachment	11
3.1.2	Form-fit attachment	11
3.2	TROVIS 5725-3	12
3.2.1	Force-locking attachment	12
3.2.2	Form-fit attachment	12
3.3	Mounting position	14
3.4	Travel indication scale	14
4	Electrical connection	15
5	Manual operation without TROVIS-VIEW	18
5.1	Changing the travel position	18
5.1.1	TROVIS 5724-3	18
5.1.2	TROVIS 5725-3	18
5.2	Changing the set point W1	19
6	Dimensions in mm	20
7	Functions	23
7.1	DHW heating in instantaneous heating system	23
7.1.1	DHW tapping recognition with a flow switch	24
7.1.2	Tapping detection using the water flow sensor	25
7.2	Set point changeover	25
7.3	Maintaining the heat exchanger at a constant temperature	26
7.4	Excessive temperature protection	27
7.5	Frost protection	27
7.6	Control parameters	27
7.7	External demand processing	28
7.8	Function of switching output	29

7.9	Operating direction.....	29
7.10	Manual mode.....	30
7.10.1	Handwheel.....	30
7.10.2	Manual setting.....	30
7.10.3	Command mode.....	31
7.10.4	Manual level in TROVIS-VIEW	31
8	Additional readings and functions in the TROVIS-VIEW software	32
8.1	Operating information	32
8.2	Operating states	32
8.3	Functions	33
8.4	Status messages.....	33
8.5	Statistics.....	34
9	Configuration list and customer settings.....	35
9.1	Function block list.....	35
9.2	Parameter list.....	36
9.3	Customer setting	37
10	Nameplate.....	38
11	Customer inquiries	39

Firmware revisions	
2.11 (old)	2.13 (new) Additional setting option "Circulation pump (heating) reversed" in F16 – Function of switching output .

1 General safety instructions

For your own safety, follow these instructions concerning the mounting, start up, and operation of the device:

- The device is to be mounted, started up or operated only by trained and experienced personnel familiar with the product. According to these mounting and operating instructions, trained personnel refers to individuals who are able to judge the work they are assigned to and recognize possible dangers due to their specialized training, their knowledge and experience as well as their knowledge of the applicable standards.
- Any hazards that could be caused in the valve by the process medium and the operating pressure or by moving parts are to be prevented by taking appropriate precautions.
- The device is designed for use in low voltage installations. For wiring and maintenance, you are required to observe the relevant safety regulations. Only use protective equipment that can be protected against unintentional reconnection of the power supply.
- Before wiring the actuator, disconnect it from the power supply.

To avoid damage to any equipment, the following also applies:

- Proper shipping and storage are assumed.

**Note:**

Devices with a CE marking fulfill the requirements of the Directives 2004/108/EC and 2006/95/EC. The Declaration of Conformity is available on request.

2 Design and principle of operation

The TROVIS 5724-3 and TROVIS 5725-3 Electric Actuators with Process Controller consist of a linear actuator with an integrated digital controller.

They are especially designed for DHW heating in instantaneous heating systems for small to medium-sized buildings and for fixed set point control circuits in mechanical engineering applications. They are particularly suitable for mounting to SAMSON Types 3213, 3214, 3260, 3222, and 3226 Valves.

A special version of Type 3222 (DN 25) and Type 3222 N DN 15) with a special plug design is available for small installations

(apartment or house). As a result, even small tapping amounts can be controlled.

The integrated digital controller must be connected to a temperature sensor on the input side, which can be optionally upgraded by a water flow sensor or a flow switch.

Alternatively, a current signal can be used for mechanical engineering applications.

The set point of the digital controller is set to 60 °C and can be changed manually at the set point potentiometer (11) or in the TROVIS-VIEW software.

The actuator contains a reversible synchronous motor and a maintenance-free gear.

The force-locking version is connected directly to the valve using a coupling nut (4), whereas the form-fit version is connected to the valve using a stem connector.

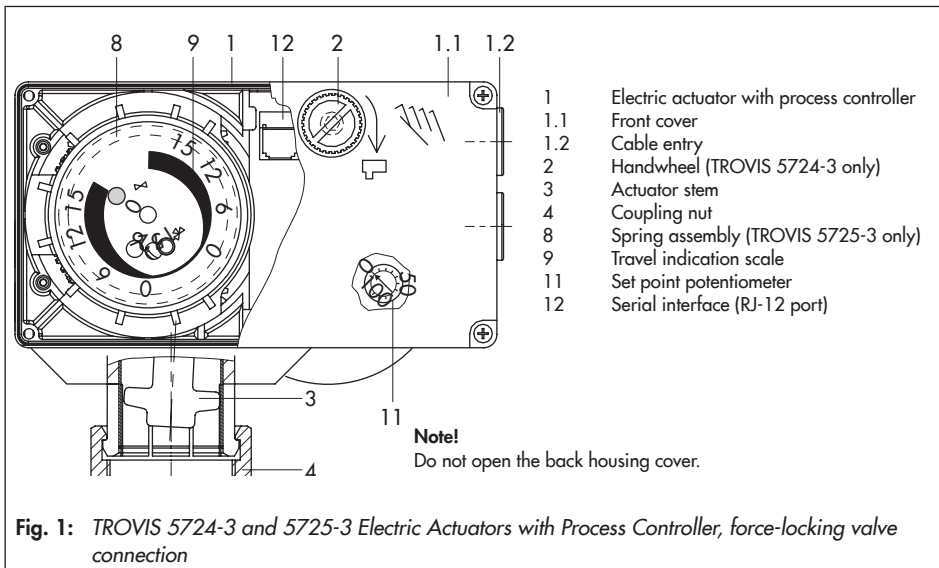

TROVIS 5724-3 without fail-safe action

The force of the electric motor is transmitted via gearing and crank disk to the actuator stem (3) and, as a result, to the plug stem of the mounted valve.

The motor is switched off by torque-dependent switches in the end positions or in case of overload.

When the actuator stem retracts, the plug stem of the force-locking version follows the movement of the spring installed in the valve.

The handwheel (2) can be used to manually position the valve.

TROVIS 5725-3 with fail-safe action

The actuator contains a spring mechanism (8) and an electromagnet. The actuator is moved by the force of the spring to the fail-safe position when the electromagnet (terminals L and N) is de-energized. The direction of action depends on the actuator version and cannot be reversed.

**NOTICE**

Do not use the magnet to control the valve position.

A handwheel (2) is not fitted on the housing cover of TROVIS 5725-3. Manual override is possible, after removing the front cover, using a 4 mm Allen key (see section 5.1.2).

Testing according to DIN EN 14597

The force-locking versions of the electric actuators with process controller with fail-safe action are tested by the German Technical Inspectorate (TÜV) according to DIN EN 14597.

The register number is written on the nameplate.

2.1 Accessories

Communication

- **TROVIS-VIEW** software (6661-1060) for revision 2 of the TROVIS 5724-3 and TROVIS 5725-3 Electric Actuator with Process Controller is required. The TROVIS-VIEW software can be downloaded free of charge from our website (▶ www.samson.de at Services > Software > TROVIS-VIEW). The software can also be supplied on a CD-ROM. Further details in Data Sheet ▶ T 6661.
- **Hardware package**
Accessories for data transmission (including memory pen-64, connecting cable and modular adapter), order no. 1400-9998
- **Memory pen-64**
For indirect data transmission, order no. 1400-9753

DHW heating in instantaneous heating system

- Type 5207-0060 **Temperature Sensor**, optimized Pt 1000 temperature sensor with fast response which is simple to install
- **Sensor pocket**
For Type 5207-0060 Pt 1000 Sensor for mounting to heat exchangers with G $\frac{3}{4}$ for optimal positioning instantaneous heating systems, order no. 1400-9249
- **Water flow sensor**
Axial turbine flowmeter for liquids and associated extension cable with mating connector, order no. 1400-9246
- **Flow switch**
To recognize when hot water is being tapped using an NO contact

2.2 Technical data

Electric actuator with process controller	TROVIS	5724						5725					
		-310	-313	-320	-323	-330	-333	-310	-313	-320	-323	-330	-333
Fail-safe action		Without						With					
Direction of action		–						Extends					
Rated travel	mm	6	6	12	12	15	15	6	6	12	12	15	15
Transit time for rated travel	s	35	18	70	36	90	45	35	18	70	36	90	45
Transit time for fail-safe action	s	–						4	4	6	6	7	7
Thrust	N	700						500			280		
Thrust in the event of fail-safe action	N	–						500			280		
Attachment	Force-locking	•	•	•	•			•	•	•	•		
	Form-fit					•	•					•	•
Handwheel		Yes						Possible ¹⁾					

Electric actuator with process controller	TROVIS	5724						5725					
		-310	-313	-320	-323	-330	-333	-310	-313	-320	-323	-330	-333
Fail-safe action		Without						With					
Direction of action		–						Extends					
Power supply		230 V (±10 %), 50 Hz						230 V (±10 %), 50 Hz					
Power consumption	Approx. VA	3	7	3	7	3	7	5	9	5	9	5	9
Permissible temperatures ⁵⁾													
Ambient		0 to 50 °C						0 to 50 °C					
Storage		–20 to +70 °C						–20 to +70 °C					
Safety													
Degree of protection		IP 54 ⁴⁾						IP 54 ⁴⁾					
Class of protection		II (according to EN 61140)											
Overtoltage category		II (according to EN 60664)											
Degree of contamination		2 (according to EN 60664)											
Electromagnetic compatibility		According to EN 61000-6-2, EN 61000-6-3 and EN 61326											
Vibration		According to EN 61000-6-2 and EN 60068-2-27											
Compliance													
Inputs and outputs													
Binary input BI1 ³⁾		Floating contact for internal set point switchover or to deactivate the function to maintain the heat exchanger at a constant temperature											
Binary input BI2 ³⁾		Floating contact to connect the flow switch											
Switching output		230 V/50 Hz, max. 1 A											
Weight	kg (approx.)	1.1						1.3					
Accessories													
Temperature sensor		Pt 1000, fast response											
Water flow sensor		530 pulses/l, measuring range 1 to 30 l/min											
Flow switch ²⁾		Yes - Alternative to water flow sensor											

- 1) Manual override using 4 mm Allen key (after removing the cover); actuator always returns to fail-safe position after release.
- 2) The flow switch or water flow sensor is not required in DHW heating in instantaneous systems with a constant circulation.
- 3) Recommendation: use devices with gold contacts when using relays.
- 4) Up to device index .03 only when the actuator is installed in the upright position. See last two figures of the configuration ID written on the nameplate (see page 38), e.g. Var.-ID xxxxxxx.xx, for the device index.
- 5) The permissible medium temperature depends on the valve on which the electric actuator is mounted. The limits specified in the valve documentation apply.

2.3 LED blinking pattern

The device has a red and a yellow LED which indicate the operating states of the device.

The LEDs are located underneath the front cover on top of the circuit board.

Blinking pattern of the yellow LED

- Device switched off or command mode

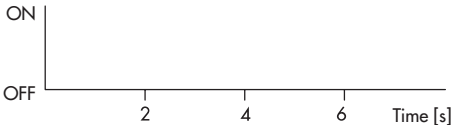

- Device switched on or memory pen action completed

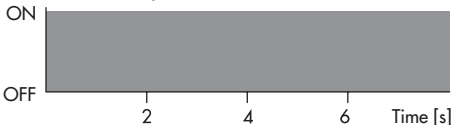

- Plausibility error in memory pen

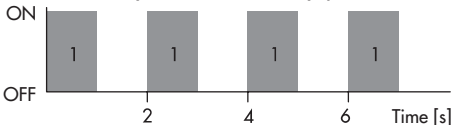

- Preparing to read data from memory pen

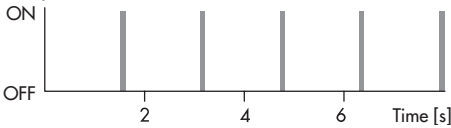

- Preparing to write data to memory pen

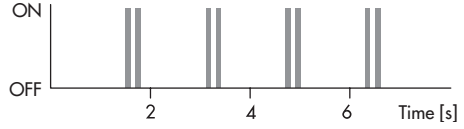

- Preparing data logging

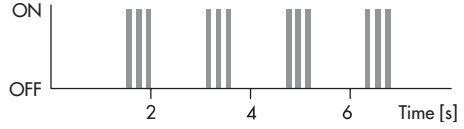

- Data logging in progress

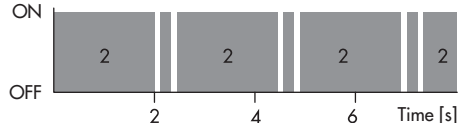

- EEPROM error in memory pen

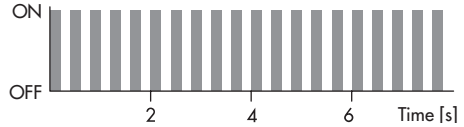

Blinking pattern of the red LED

- Normal operation or memory pen inserted

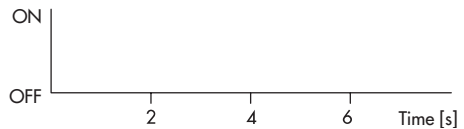

- Device starting up

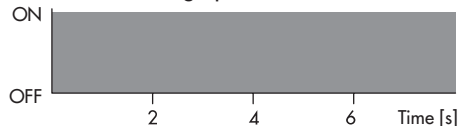

- Temperature too high (upper limit value GWH exceeded)

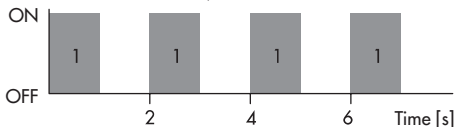

- EEPROM error in device

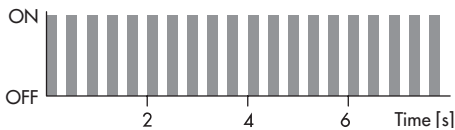

- Zero calibration in progress

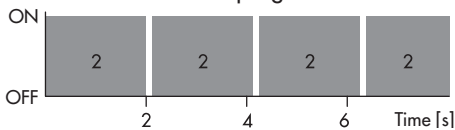

- Internal transit time measurement

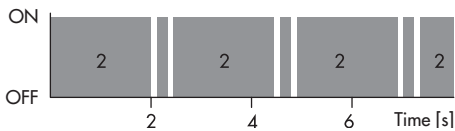

- Wire breakage at temperature input

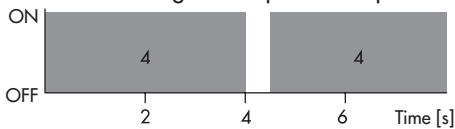

- Wire breakage at current input

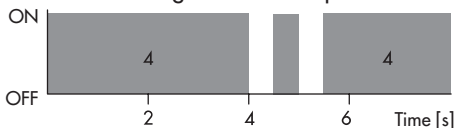

- Flow rate at water flow sensor exceeds measuring range

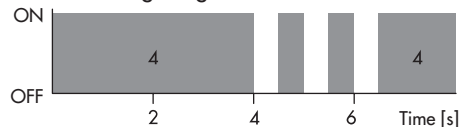

3 Attachment to the valve

The actuator is mounted either directly onto the valve (force-locking) or using a stem connector (form-fit) depending on the valve version used.

3.1 TROVIS 5724-3

3.1.1 Force-locking attachment

1. Turn the handwheel (2) counterclockwise to retract the actuator stem (3).
2. Place the actuator on the valve connection and tighten the coupling nut (4) (tightening torque 20 Nm).

3.1.2 Form-fit attachment

1. Place the actuator on the yoke (15) and tighten the coupling nut (4) (tightening torque 20 Nm).
2. Place actuator with yoke (15) on the valve and tighten the nut (17) (min. tightening torque 150 Nm).

3. Pull plug stem until it reaches the actuator stem or extend actuator stem using the handwheel (2).
4. Position the clamps of the stem connector (16) included in the accessories on the ends of the actuator stem and plug stem and screw tight.

3.2 TROVIS 5725-3

3.2.1 Force-locking attachment

1. Unscrew front cover and place a 4 mm Allen key on the red actuating shaft.
2. Turn Allen key counterclockwise only and only as far as the final travel value which is at the point where the torque-dependent limit switch is activated (switching off the synchronous motor).



NOTICE

Turning the actuator too far will destroy it.

3. Hold Allen key in place and fasten valve and actuator together using the coupling nut (tightening torque 20 Nm).
4. Remove Allen key and carefully refasten the front cover.

3.2.2 Form-fit attachment

→ Proceed as described in section 3.1.2.

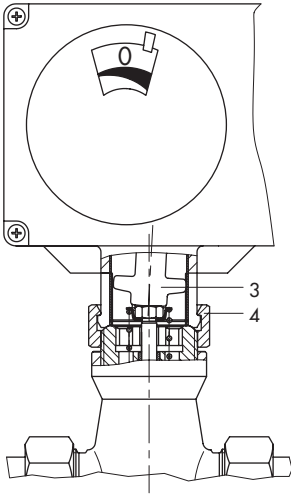

Force-locking attachment with coupling nut,
e.g. to Type 3222 Valve

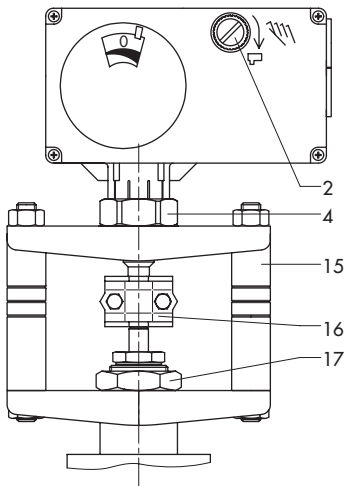

Form-fit attachment with stem
connector, e.g. on Series V2001 Valve

- 2 Handwheel (TROVIS 5724-3 only)
- 3 Actuator stem
- 4 Coupling nut
- 15 Yoke
- 16 Stem connector
- 17 Nut

Fig. 2: Attaching actuator and valve

3.3 Mounting position

The control valve can be installed in the pipeline in any desired position. However, a suspended mounting position of the actuator is not permissible (see Fig. 3).

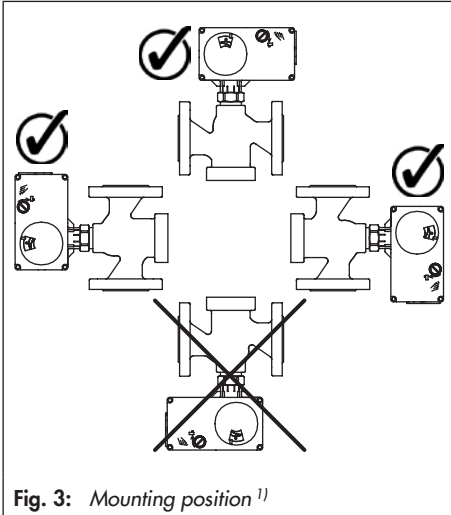

Fig. 3: Mounting position ¹⁾

¹⁾ The degree of protection IP 54 can only be achieved up to device index .03 when the actuator is installed in the upright position. See last two figures of the configuration ID written on the nameplate (see page 38), e.g. Var-ID xxxxxxx.xx, for the device index.

3.4 Travel indication scale

The travel indication scale has two opposed scales. Which scale is to be used depends on the valve version (see Fig. 4):

Globe valves and three-way diverting valves

The driving pin is in position 0 (delivered state).

Three-way mixing valves

Remove scale, turn it and replace it so that the pin is positioned over the appropriate hole (6, 12 or 15) corresponding to the rated travel (6, 12 or 15 mm travel).

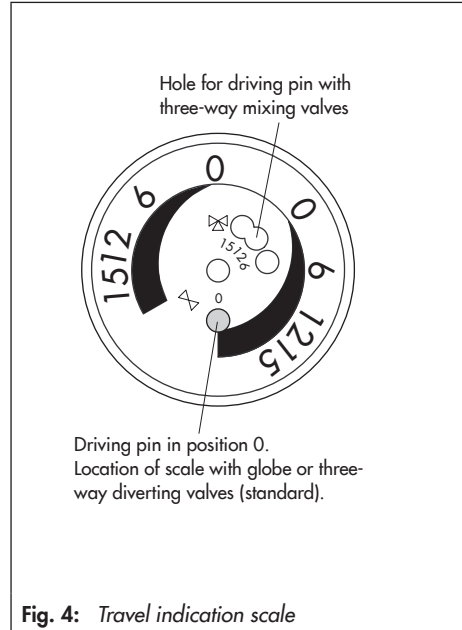

Fig. 4: Travel indication scale

4 Electrical connection



Risk of electric shock

Upon installation of the electric cables, you are required to observe the regulations concerning low-voltage installations according to DIN VDE 0100 as well as the regulations of your local power supplier. Use a suitable power supply which guarantees that no dangerous voltages reach the device in normal operation or in the event of a fault in the system or any other system parts. Connect the actuator to the electrical network only after the power supply is first switched off. Make sure the power cannot be switched on unintentionally.

The actuator requires a fast-response Pt 1000 sensor to be connected for it to function.

Two set points W1 and W2 can be used. The binary input B11 is used to switch between the set points.

In addition, a water flow sensor or a flow switch can be connected to quickly recognize when hot water is being tapped.

Alternatively, instead of the Pt 1000 sensor, the current input 0/4 to 20 mA can be used for control purposes in mechanical engineering applications.

The connected temperature sensor and the current input configured as 4 to 20 mA are monitored for line breakages.

A fault in the line of a sensor is indicated by the red LED blinking slowly.



Note:

A faulty sensor line cannot be detected when a 0 to 20 mA input signal is used.

→ Perform the electrical connection depending on the application according to one of the following wiring diagrams (Fig. 5).

As soon as the actuator is connected to the power supply, the initialization procedure starts.

The actuator stem extends (when the direction of action increasing/increasing has been set) and the red and yellow LEDs under the serial interface are illuminated.

As soon as the actuator stem has reached the final position, the red LED is turned off.

The yellow LED remains illuminated and indicates that the actuator is ready to operate.

DHW heating in instantaneous heating system

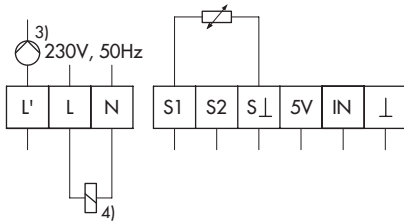

Operation with Pt 1000 sensor

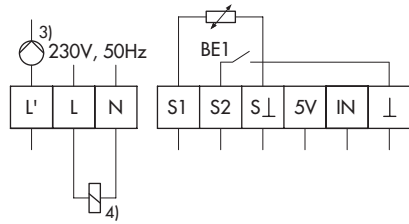

Operation with Pt 1000 sensor and binary contact to switch between set points

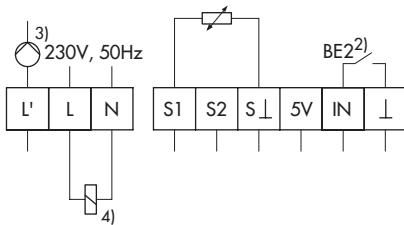

Operation with Pt 1000 sensor and flow switch

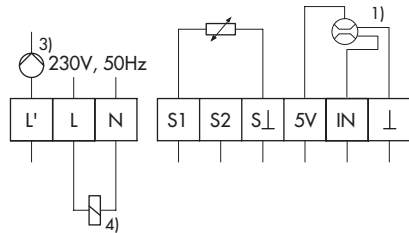

Operation with Pt 1000 sensor and water flow sensor
(see Fig. 6 for information for connection of water flow sensor)

Mechanical engineering applications

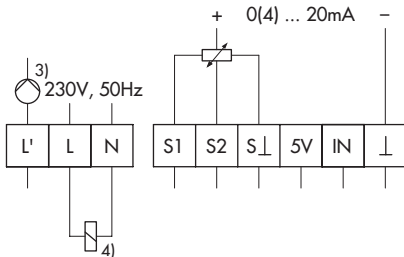

Operation with Pt 1000 sensor and set point guided by current input

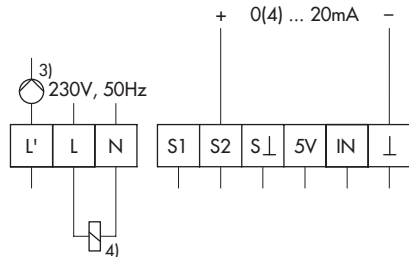

Operation with current input

1) Water flow sensor
2) Flow switch

3) Pump or fault alarm output
4) Electromagnet (TROVIS 5725-3 only)

Fig. 5: Electrical connections

Connection of water flow sensor (WWS)

Connection of water flow sensor (WWS)

	WSS		Extension cable		TROVIS 5724-3	
GND	BK	—	—	BN	—	⊥
Signal	GN	—	—	GN	—	IN
5 V	WH	—	—	WH	—	5 V

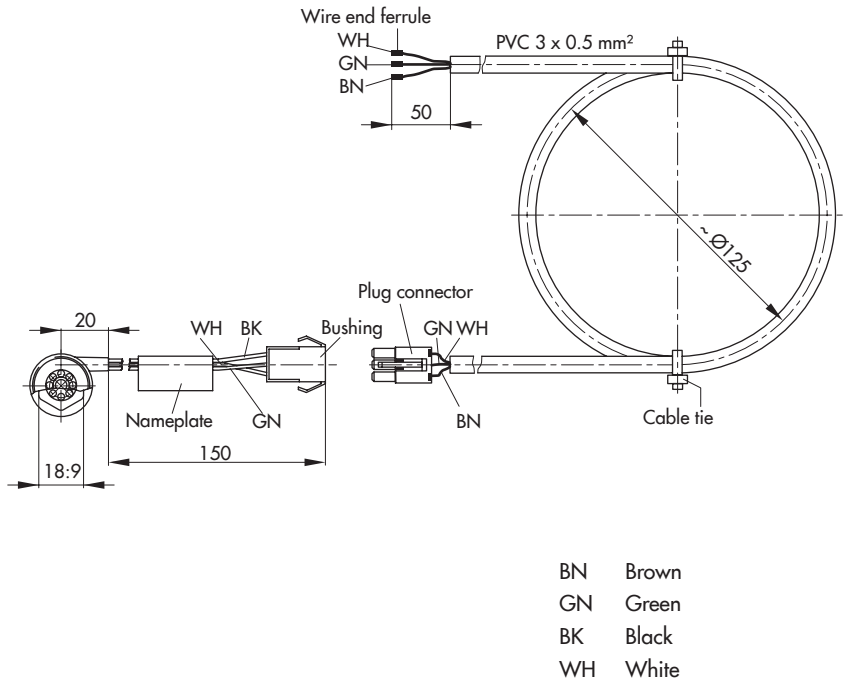

Fig. 6: Connection of water flow sensor (WWS)

5 Manual operation without TROVIS-VIEW

5.1 Changing the travel position

Travel and direction of action can be read off the scale of the travel indicator (see Fig. 7).

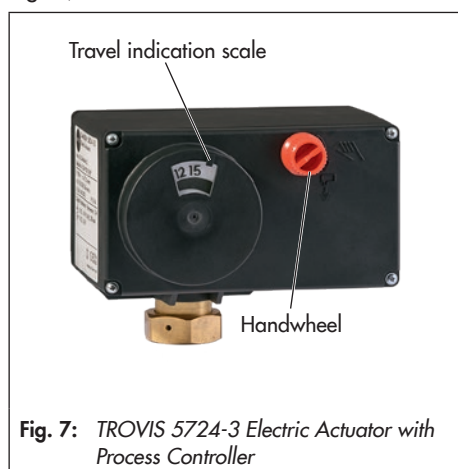

Fig. 7: TROVIS 5724-3 Electric Actuator with Process Controller

5.1.1 TROVIS 5724-3

Use the handwheel to adjust the travel (see Fig. 7):

- Turn clockwise to extend the actuator stem (approx. 4 turns for 1 mm travel).
- Turn counterclockwise to retract the actuator stem (approx. 4 turns for 1 mm travel).

5.1.2 TROVIS 5725-3



DANGER!

Risk of electric shock from exposed live parts.

Do not touch live parts on operating the manual override.

1. Unscrew front cover and place a 4 mm Allen key on the red actuating shaft.
2. Turn Allen key counterclockwise only and only as far as the final travel value which is at the point where the torque-dependent limit switch is activated (switching off the synchronous motor).



NOTICE

Risk of damage to the actuator by turning it too far.

Only retract the actuator stem as far as the final travel value.

Once the magnet has been released, the spring mechanism pushes the actuator stem back to the fail-safe position.

3. Remove Allen key and carefully refasten the front cover.

5.2 Changing the set point W1

The default settings of set point W1 is 60 °C and W2 is 70 °C.

These set point can be changed in the TROVIS-VIEW software.

To manually adjust the W1 set point without TROVIS-VIEW, turn the set point potentiometer (11 in Fig. 1) located on the printed circuit board of the actuator. The adjustable setting range is between 10 and 100 % of the measuring range (default: lower measuring range value $X_{min} = 0$ °C and upper measuring range value $X_{max} = 100$ °C).

In the delivered state, the set point potentiometer is set to 0 %, i.e. it does not have any effect on W1 set point (60 °C).

Additional points that apply:

Device with firmware 2.10 or lower:

→ The set point potentiometer only takes effect when the actual value originates from a Pt 1000 sensor. In the combination with **F05 - 1** (Current input active) and **F06 - 1** (Current input function = set point), the set point potentiometer is not active.

Device with firmware 2.11 or higher:

The set point can be adjusted even when using the current input.

→ The manually adjusted value at the set point potentiometer for W1 is only used for control if function block **F12** in TROVIS-VIEW is set to 1 (Automatic set point potentiometer: manual setting effective above 10 %), see section 7.10.2.

The required setting **F12 - 1** is the default setting.

- The set point W2 can only be changed in TROVIS-VIEW.
1. Unscrew front cover.
 2. Set W1 set point as required at the set point potentiometer (11 in Fig. 1).

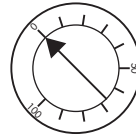

Setting range: 0 to 100 % of the measuring range (default setting 0 to 100 °C)
Do not forget to check the automatic set point potentiometer function.

3. Carefully refasten the front cover.

Function of automatic set point potentiometer

- Any setting **below 10 %** at the set point potentiometer is ignored by the controller. The controller uses the W1 set point from the parameter list (TROVIS-VIEW software) for control.
- Any setting **above 10 %** at the set point potentiometer is used by the controller for control. The W1 set point entered in TROVIS-VIEW is ignored.

6 Dimensions in mm

TROVIS 5724-313/-323
TROVIS 5725-313/-323

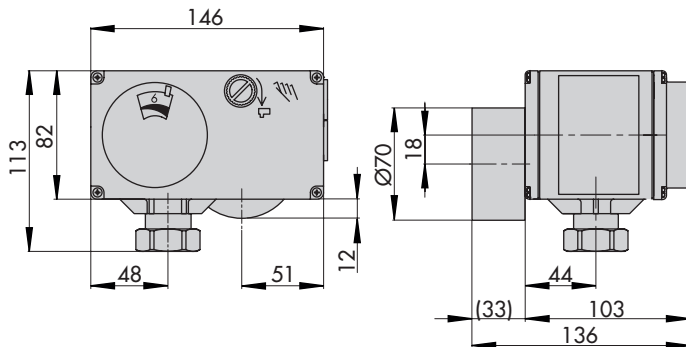

TROVIS 5724-333
TROVIS 5725-333

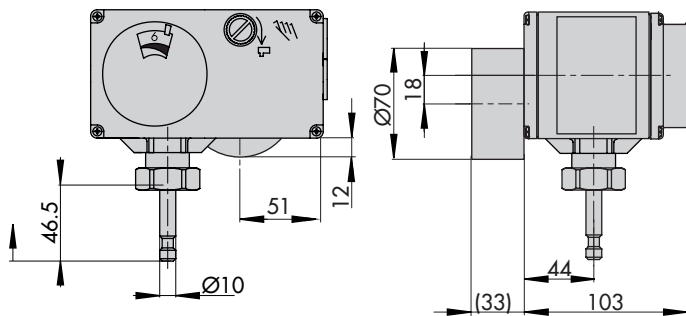

TROVIS 5724-310/-320
TROVIS 5725-310/-320

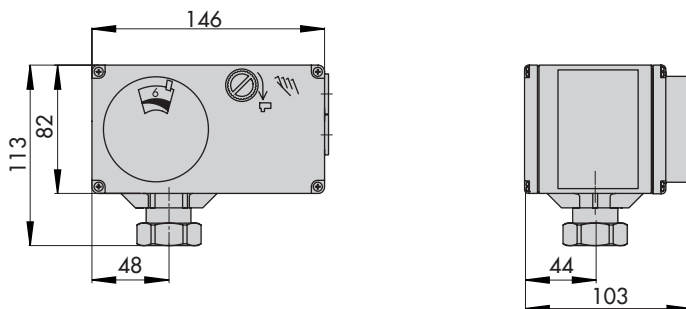

TROVIS 5724-330
TROVIS 5725-330

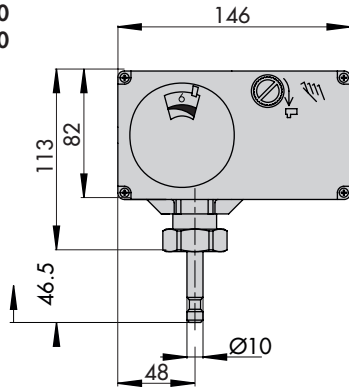

Accessories for domestic hot water heating

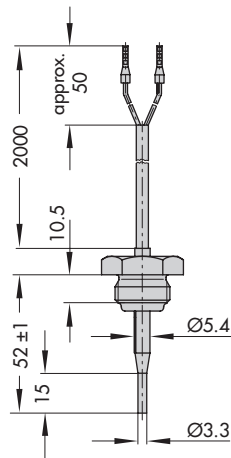

Type 5207-0060 Pt 1000 Sensor
Time response: $t_{0,5} < 1 \text{ s}$, $t_{0,9} < 3 \text{ s}$; in water 0.4 m/s
PN 16
Max. medium temperature: 80 °C

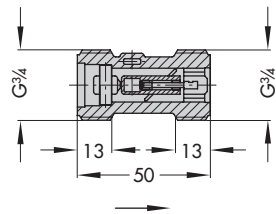

Water flow sensor with extension cable

Order no. 1400-9246
Measuring range 1 to 30 l/min,
DN 10, PN 10, IP 54
max. medium temperature: 70 °C
Extension cable length: 2 m

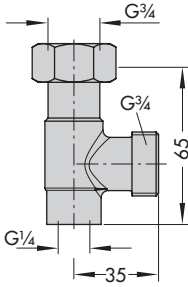

Sensor pocket (including gasket)
for heat exchanger with G $\frac{3}{4}$
Order no. 1400-9249

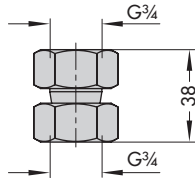

Connecting piece (including gasket)
for valve G $\frac{3}{4}$
Order no. 1400-9236

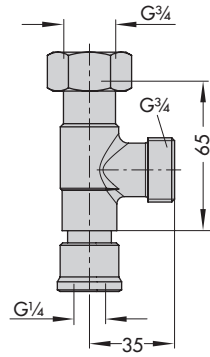

Circulation pipe connection
(including gasket)
Order no. 1400-9232

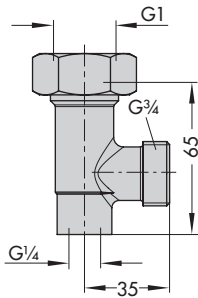

Sensor pocket (including gasket)
for heat exchanger with G 1
Order no. 1400-9252

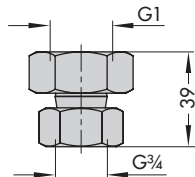

Connecting piece (including gasket)
for valve G 1
Order no. 1400-9237

7 Functions

The functions and parameters are changed in the TROVIS-VIEW software.

7.1 DHW heating in instantaneous heating system

The DHW temperature is controlled to the set point temperature in DHW heating in instantaneous heating systems:

- ➔ If the DHW temperature falls below the set point, the actuator opens the valve (pulses) to increase the DHW temperature.
- ➔ If the DHW temperature exceeds the set point, the actuator closes the valve (pulses) to reduce the DHW temperature.

Functions	WE	Configuration
F01 – DHW tapping recognition	1	F01 - 0

Parameters	WE	Value range
P01 – Set point W1	60 °C	0 to 100 °C
P02 – Set point W2	70 °C	0 to 100 °C

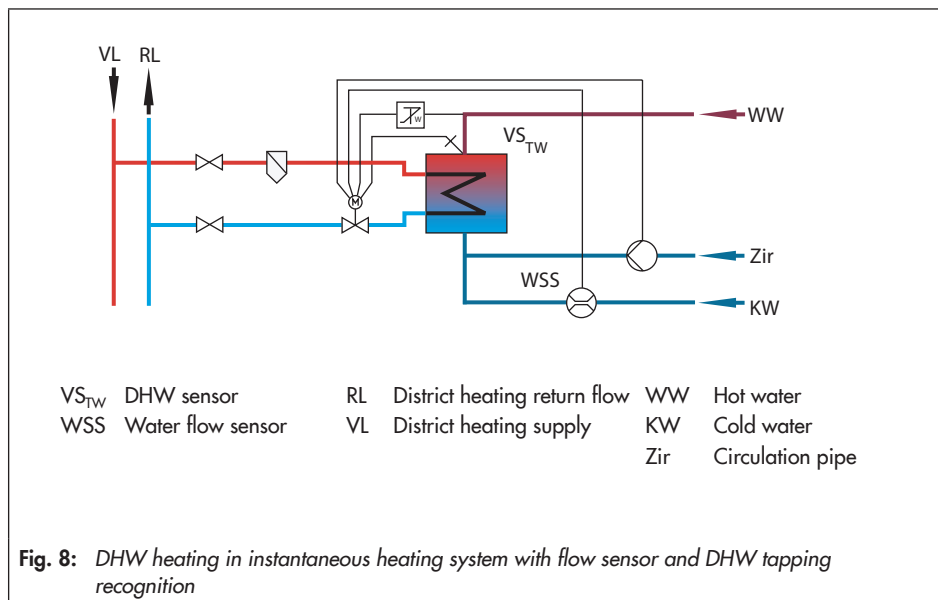

Operation with a DHW sensor

A Pt 1000 temperature sensor (e.g. Type 5207-0060, ideally combined with a sensor pocket to provide the best positioning of the sensor at the heat exchanger) measures the DHW temperature at the heat exchanger. The measured temperature is compared with the set point and the valve is moved accordingly to achieve this temperature (see above).

Operation with a current input

As an alternative to a flow sensor, the input of the current flow temperature can be also be implemented by the current input (0 to 20 mA or 4 to 20 mA). The input signal is based on the measuring range (Xmin to Xmax). The measured DHW temperature is compared with the set point and the valve is moved accordingly to achieve this temperature (see above).



Note:

The function to maintain the heat exchanger at a constant temperature (see section 7.3) cannot be used when the current input is active.

Functions	WE	Configuration
F05 – Current input	0	F05 - 1
F06 – Function of current input	0	F06 - 0
F07 – Measuring range of current input	0	F07 - 0: 0 to 20 mA F07 - 1: 4 to 20 mA
Parameters	WE	Value range
P03 – Lower measuring range value Xmin	0 °C	0 to 60 °C
P04 – Upper measuring range value Xmax	100 °C	95 to 150 °C

7.1.1 DHW tapping recognition with a flow switch

The flow switch is used to indicate when DHW tapping is starts and finishes. A closed contact causes the pump to start running (the DHW temperature control at the DHW sensor is active). An open contact causes the valve to close and the pump to be switched off.

Functions	WE	Configuration
F01 – DHW tapping recognition	1	F01 - 1
F02 – Flow rate sensor	1	F02 - 0

7.1.2 Tapping detection using the water flow sensor

In contrast to the DHW tapping recognition with a flow switch, the extent of tapping is indicated as well as when the DHW tapping starts and finishes.

By activating the optimizing function **Adaptation**, the device adapts itself to changing network conditions without having to change the control parameters (see section 7.6). The optimizing function can only be activated when a water flow sensor is used.

Functions	WE	Configuration
F05 – Current input	1	F01 - 1
F06 – Function of current input	1	F02 - 1
F07 – Measuring range of current input	1	F03 - 1

7.2 Set point changeover

The device can use two different set points, W1 and W2, for control, e.g. hot water temperature in normal used and for thermal disinfection. The set points changeover is implemented by the binary input (BI1):

- BI1 open: W1 is the set point
- BI1 closed: W2 is the set point

It is only possible to change between set points W1 and W2 when the DHW temperature is measured with a Pt 1000 resistance sensor (F05 - 0).



Note:

*When the binary input BI1 is used, the current input cannot be used. It also not possible to deactivate **the function to maintain the heat exchanger at a constant temperature** (see section 7.3) when the binary input is used for set point switchover.*

Functions	WE	Configuration
F05 – Current input	0	F05 - 0
F08 – Function of binary input	0	F08 - 1

7.3 Maintaining the heat exchanger at a constant temperature

When the **DHW tapping recognition** is active, the actuator controls the hot water to the set point temperature only when hot water is demanded. To guarantee that the temperature reaches the set point W1 quickly when hot water is demanded again, the heat exchanger is prevented from cooling down by the function **to maintain the heat exchanger at a constant temperature**: the hot water is kept at a temperature reduced by the *set-back difference*.

Depending on the configuration, the reduced set point applies after hot water has been tapped until the next demand or while the function *to maintain heat exchanger at a constant temperature* (P12) is active.



Note:

Upon power supply failure, an active function is canceled. After the power supply is reconnected, hot water must be tapped to reactivate the function.

Functions	WE	Configuration
F01 – DHW tapping recognition	1	F01 - 1
F09 – Maintaining exchanger at constant heat	0	F09 - 0: Time adjustable (P12) F09 - 1: Continuous

Parameters	WE	Value range
P11 – Set-back difference	8 K	0 to 30 K
P12 – Heating period for heat exchanger	24 h	0 to 48 h

Influence of the binary input B11

If the binary input B11 is not required for set point switchover, it is used to deactivate the function to maintain the heat exchanger at a constant temperature.

- B11 open: 0: function **to maintain heat exchanger at a constant temperature** according to configuration of F09.
- B11 closed: function inactive

When the binary input B11 is closed, an active function to maintain the heat exchanger at a constant temperature is immediately terminated, even when the *heating period for heat exchanger* has not yet elapsed.



Note:

When the binary input is active, the current input cannot be used.

Functions	WE	Configuration
F05 – Current input	0	F05 - 0
F08 – Function of binary input	0	F08 - 0

7.4 Excessive temperature protection

The actuator closes the valve when the flow temperature at the flow sensor exceeds the upper limit (GWH).

When F10 - 0 is configured, **no** monitoring of the flow temperature for violation of the upper limit takes place.

Functions	WE	Configuration
F10 – Upper limit (GWH)	0	F10 - 1

Parameters	WE	Value range
P05 – Upper limit (GWH)	95 °C	0 to 100 °C

7.5 Frost protection

When the function is active, the flow temperature is monitored for violation of the lower limit. When the temperature falls below the *lower limit (GWL)*, the actuator opens the valve (pulses) until the temperature exceeds the lower limit plus hysteresis.

When F11 - 0 is configured, **no** monitoring of the flow temperature for violation of the lower limit takes place.

Functions	WE	Configuration
F11 – Lower limit (GWL)	0	F11 - 1

Parameters	WE	Value range
P06 – Lower limit (GWL)	5 °C	0 to 20 °C

7.6 Control parameters

Parameters	WE	Value range
P07 – Proportional-action coefficient KP	0.6	0.1 to 50
P08 – Reset time Tn	25 s	0 to 999 s

Functions

P09 – Derivative-action time T_v	0 s	0 to 999 s
P10 – Actuator transit time T_y	35 s	0 to 240 s

The actuator transit time T_y *actuator transit time for valve travel* (P10) reflects the time that the valve needs to move through the range from 0 to 100 % without stopping. The default setting is 35 s.

Travel	Transit time
6 mm	35 s
12 mm	70 s
15 mm	90 s



Note:

The default setting is based on a travel of 6 mm. The transit time must be adjusted for the required travel range. Alternatively, it can be determined by the "Start transit time measurement" parameter. See section 8.3.

7.7 External demand processing

The device can process an external demand for heat depending on the configuration. A measuring range (X_{min} to X_{max}) is assigned to the current signal (0 to 20 mA or 4 to 20 mA, set point). The external hot water set point has priority over the internal set point.



Note:

Only a Pt 1000 sensor can be used to measure the hot water temperature when the function for an external demand is active.

Functions	WE	Configuration
F05 – Current input	0	F05 - 1
F06 – Function of current input	0	F06 - 1
F07 – Measuring range of current input	0	F07 - 0: 0 to 20 mA F07 - 1: 4 to 20 mA

Parameters	WE	Value range
P03 – Lower measuring range value X_{min}	0 °C	0 to 60 °C
P04 – Upper measuring range value X_{max}	100 °C	95 to 150 °C

7.8 Function of switching output

The switching output can be configured as either a pump output (circulation pump for the DHW circuit or heating circuit), a fault alarm output or an output to report when hot water is being tapped.

Passive function:	The switching output is inactive.
Function of the fault alarm:	The switching output is active when a fault has occurred.
Function of the circulation pump (DHW):	The switching output is active while hot water is being tapped, when the function to maintain the hot water at a constant temperature or the frost protection function is active.
Function of the circulation pump (heating):	The switching output is active after a demand for heat (valve position > 0 %).
Function of the tapping:	The switching output is active while hot water is being tapped.
Function of the circulation pump (heating) reversed:	The switching output is active after a demand (valve position < 100 %).

Functions	WE	Configuration
F16 – Function of switching output	3	F16 - 1: Passive F16 - 2: Fault alarm F16 - 3: Circulation pump (DHW) F16 - 4: Circulation pump (heating) F16 - 5: Tapping F16 - 6: Circulation pump (heating) reversed

7.9 Operating direction

Increasing/increasing (F04 - 0)

- Actual value < Set point: Actuator stem retracts
- Actual value > Set point: Actuator stem extends

Increasing/decreasing (F04 - 1)

- Actual value < Set point: Actuator stem extends
- Actual value > Set point: Actuator stem retracts

Actuator stem extended

- With globe valves: Valve CLOSED
- With three-way mixing valves: Port A → AB open, B → AB closed (see Fig. 9)
- With three-way diverting valves: Port AB → A closed, AB → B open

Actuator stem retracted

- With globe valves: Valve OPEN
- With three-way mixing valves: Port A → AB closed, B → AB open (see Fig. 9)
- With three-way diverting valves: Port AB → A open, AB → B closed

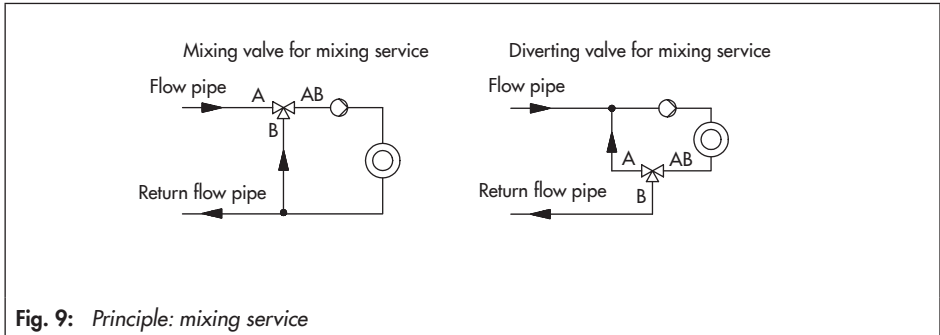

Fig. 9: Principle: mixing service

Functions	WE	Configuration
F04 - Direction of action	0	F04 - 0: Increasing/increasing >> F04 - 1: Increasing/decreasing <<

7.10 Manual mode

7.10.1 Handwheel

➔ See section 5.1.

7.10.2 Manual setting

The function block F12 for a manually adjusted set point determines whether a set point W1 adjusted at the set point potentiometer is to be used for control (see section 5.2). The following applies:

- **F12 - 0:** The W1 set point entered in TROVIS-VIEW applies regardless of the setting at the set point potentiometer. The set point potentiometer setting is overridden.
- **F12 - 1:** (Automatic set point potentiometer) Settings at the set point potentiometer are used for control when the value is higher than 10 %. The internal W1 or W2 set point entered in TROVIS-VIEW is used when the values are below 10 %.

Functions	WE	Configuration
F12 – Set point manual	1	F12 - 0: No manual adjustment F12 - 1: Automatic set point potentiometer

7.10.3 Command mode

A memory pen can be configured in TROVIS-VIEW to be a command pen. The command pen allows the actuator stem to be moved to the open and closed positions.



Note:

The action of retracting/extending the actuator stem on inserting the command pen has absolute priority. The input signal is overridden.

→ Configuration of the memory pen ► EB 6661.

7.10.4 Manual level in TROVIS-VIEW

The actuator can be switched to the manual mode using the TROVIS-VIEW software. See section 8.3.

The following actions are possible in the manual level:

- Retract actuator stem
- Extend actuator stem
- Move stem to standardized set point
- Switching output

The electric actuator leaves the manual operation mode as soon as you exit the manual level or the online mode in TROVIS-VIEW.

8 Additional readings and functions in the TROVIS-VIEW software

8.1 Operating information

In online mode the current data measured by the sensors and the active set point are listed in the [Operating values] folder.

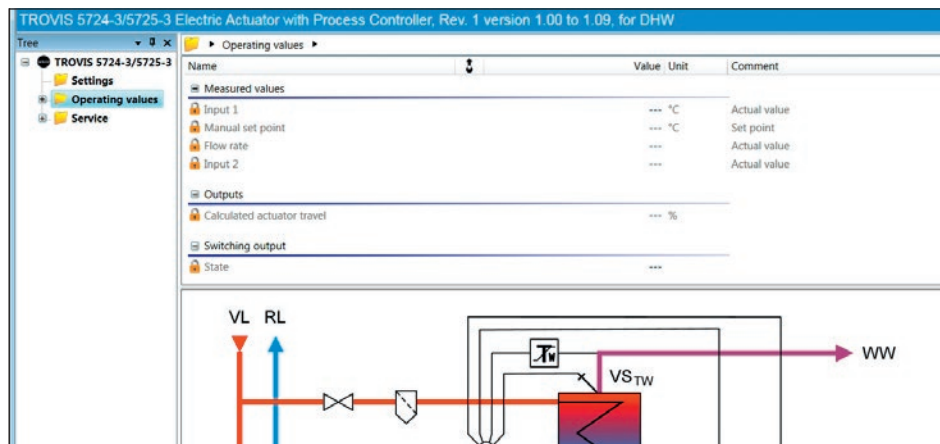

The screenshot displays the 'Operating values' section for a TROVIS 5724-3/5725-3 Electric Actuator with Process Controller, Rev. 1 version 1.00 to 1.09, for DHW. The interface is divided into a tree view on the left, a data table, and a schematic diagram at the bottom.

Tree View:

- TROVIS 5724-3/5725-3
 - Settings
 - Operating values
 - Service

Table:

Name	Value	Unit	Comment
Measured values			
Input 1	---	°C	Actual value
Manual set point	---	°C	Set point
Flow rate	---		Actual value
Input 2	---		Actual value
Outputs			
Calculated actuator travel	---	%	
Switching output			
State	---		

Schematic Diagram: The diagram shows a water supply line (WW) entering a valve assembly. The valve is controlled by a process controller (represented by a box with a triangle). The controller is connected to a temperature sensor (VS_{TW}) and a temperature display (TW). The valve is also connected to a water supply line (WW) and a return line (RL). The valve is labeled VL and RL.

8.2 Operating states

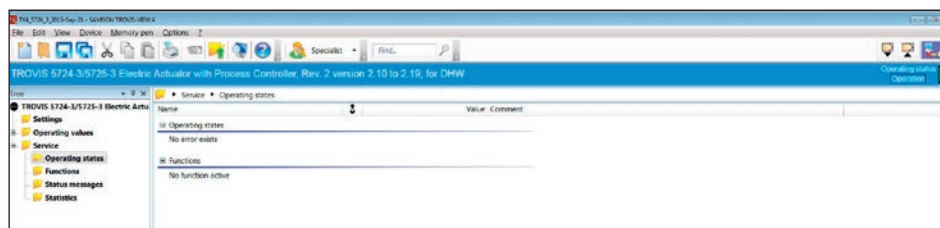

The screenshot displays the 'Operating states' section for a TROVIS 5724-3/5725-3 Electric Actuator with Process Controller, Rev. 2 version 2.10 to 2.19, for DHW. The interface is divided into a tree view on the left, a data table, and a status bar at the bottom.

Tree View:

- TROVIS 5724-3/5725-3 Electric Actuator
 - Settings
 - Operating values
 - Service
 - Operating states
 - Functions
 - Status messages
 - Statistics

Table:

Name	Value	Comment
Operating states		
No error exists		
Functions		
No function active		

Status Bar: The status bar at the bottom right indicates 'Operating status: Operative'.

8.3 Functions

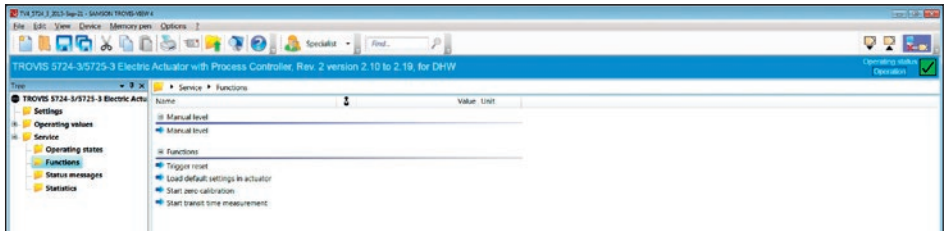

8.4 Status messages

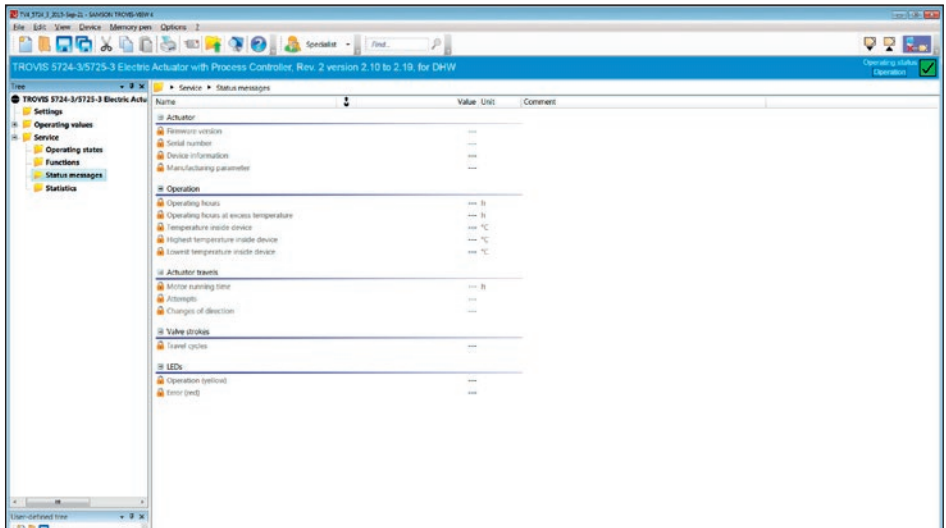

8.5 Statistics

The screenshot shows the TROVIS-VIEW software interface for a TROVIS 5724-3-5723-3 Electric Actuator. The main window displays a tree view of statistics categories and their corresponding values and comments.

Name	Value	Comment
Counter: device failures	---	---
Power supply activated	---	---
Program interruptions	---	---
Limit contact error	---	---
EEPROM error	---	---
Counter: alarms	---	---
Signal failure at temperature input	---	---
Signal failure at current input	---	---
Flow rate exceeds measuring range	---	---
Upper limit value GWH exceeded	---	---
Binary signals counters	---	---
Binary input ON	---	---
Swimming output ON	---	---
Manual set point ON	---	---
Counter: memory pen	---	---
Command: retract alarm	---	---
Command: extend alarm	---	---
Data read	---	---
Data written	---	---
Data logged	---	---
Functions counter	---	---
Configurations changed	---	---
Parameters changed	---	---
Manual foot activated	---	---
Zero calibration started	---	---
Reset triggered	---	---
Default settings loaded	---	---
Travel time measurement started	---	---

9 Configuration list and customer settings

9.1 Function block list

The function blocks F01 to F14 have the following listed functions.

F = Function block WE = Default setting 0 = OFF, 1 = ON

F	Function	WE	Meaning
01	DHW tapping recognition	1	0: Continuous control (see section 7.1) 1: Flow rate sensor active (see section 7.1.1 and section 7.1.2)
02	Flow rate sensor	1	0: Flow switch (section 7.1.1) 1: Water flow sensor (section 7.1.2)
03	Adaptation	1	0: Passive 1: Active (with water flow sensor). See section 7.1.2.
04	Direction of action	0	0: Increasing/increasing >> (see section 7.9) 1: Increasing/decreasing <> (see section 7.9)
05	Current input	0	0: Passive (binary input). See section 7.2 and section 7.3. 1: Active (see section 7.1 and section 7.7)
06	Function of current input	0	0: Actual value (see section 7.1) 1: Set point (see section 7.7)
07	Measuring range of current input	0	0: 0 to 20 mA (see section 7.1 and section 7.7) 1: 4 to 20 mA (see section 7.1 and section 7.7)
08	Function of binary input	0	0: Termination of maintaining heat exchanger at a constant temperature (see section 7.3) 1: Switchover between internal set points (see section 7.2)
09	Maintaining heat exchanger at a constant temperature	0	0: Time adjustable (see section 7.3) 1: Continuous (see section 7.3)
10	Upper limit (GWH)	0	0: No limitation 1: Violation of GWH causes Y to be set to 0 % (see section 7.4)
11	Lower limit (GWL)	0	0: No frost protection 1: Violation of GWL causes frost protection to start (see section 7.5)
12	Manual set point	1	0: No manual adjustment (see section 7.10.2) 1: Manual adjustment effective above 10 % (see section 7.10.2)

16	Function of switching output	3	1: Passive (see section 7.8) 2: Fault alarm (see section 7.8) 3: Circulation pump (DHW circuit). See section 7.8. 4: Circulation pump (heating circuit). See section 7.8. 5: Tapping (see section 7.8) 6: Circulation pump (heating) reversed. See section 7.8.
----	------------------------------	---	--

9.2 Parameter list

The parameters have the setting ranges as listed below.

P = Parameter

WE = Default setting

P	Parameters	WE	Adjustment range
01	Set point W1	60 °C	0 to 100 °C
02	Set point W2	70 °C	0 to 100 °C
03	Lower measuring range value Xmin	0 °C	0 to 60 °C
04	Upper measuring range value Xmax	100 °C	95 to 150 °C
05	Upper limit (GWH)	95 °C	0 to 100 °C
06	Lower limit (GWL)	5 °C	0 to 20 °C
07	Proportional-action coefficient K_p	0.6	0.1 to 50
08	Reset time T_n	25 s	0 to 999 s
09	Derivative-action time T_v	0 s	0 to 999 s
10	Actuator transit time T_y	35 s	0 to 240 s
11	Set-back difference	8 K	0 to 30 K
12	Heating period for heat exchanger	24 h	0 to 48 h







9.3 Customer setting

Station	
Operator	
SAMSON office	

Function blocks		
F	WE	Performed setting
01	1	
02	1	
03	1	
04	0	
05	0	
06	0	
07	0	
08	0	
09	0	
10	0	
11	0	
12	1	
16	3	

Parameters			
P	WE	Performed setting	Adjustment range
01	60 °C		0 to 100 °C
02	70 °C		0 to 100 °C
03	0 °C		0 to 60 °C
04	100 °C		95 to 150 °C
05	95 °C		0 to 100 °C
06	5 °C		0 to 20 °C
07	0.6		0.1 to 50
08	25 s		0 to 999 s
09	0 s		0 to 999 s
10	35 s		0 to 240 s
11	8 K		0 to 30 K
12	24 h		0 to 48 h

10 Nameplate

	SAMSON 1		2
	Controller with Electric Actuator		
Var.-ID	3	Model	4
Serial no.	5		6
F:	7	s:	8
		t:	9
U:	10	f:	11
		P:	12
			13
Firmware - Version:	14		
	:	15	
	:	16	

- 1 Type designation
- 2 Year of manufacture
- 3 Configuration ID
- 4 Model designation (TROVIS 5725-3 only)
- 5 Serial no.
- 6 DIN registration number (TROVIS 5725-3 only)
- 7 Thrust
- 8 Rated travel
- 9 Transit time for rated travel
- 10 Power supply
- 11 Power line frequency
- 12 Power consumption
- 13 Fail-safe action (TROVIS 5725-3 only)



Extends



Retracts

- 14 Firmware version
- 15 Inputs
- 16 Outputs

11 Customer inquiries

Please submit the following details:

- Type designation
- Configuration ID
- Serial no.
- Firmware version



SAMSON AG · MESS- UND REGELTECHNIK
Weismüllerstraße 3 · 60314 Frankfurt am Main, Germany
Phone: +49 69 4009-0 · Fax: +49 69 4009-1507
samson@samson.de · www.samson.de

EB 5724 EN

2016-03-16 · English