

Type 5757-3 Electric Actuator with Process Controller



for DHW heating



Fig. 1 · Type 5757-3

Mounting and Operating Instructions

EB 5757 EN

Firmware version 1.0x/2.0x/2.1x

Edition June 2013



Firmware versions

The Type 5757-3 Electric Actuator with Process Controller is available in various firmware versions. The firmware version is written on the nameplate of the device.

Firmware version	Additional features
2.0x	<ul style="list-style-type: none">• Switching output• Data logging function• Command mode (stem retracts/extends)
2.1x	

The Mounting and Operating Instructions are valid for all firmware versions. Differences in operation are described in these instructions.

Definitions of the signal words used in these instructions

DANGER!

indicates a hazardous situation which, if not avoided, will result in death or serious injury.

WARNING!

indicates a hazardous situation which, if not avoided, could result in death or serious injury.

NOTICE

indicates a property damage message.

Note: *Supplementary explanations, information and tips*

Contents	Page
1	General safety instructions 4
2	Design and principle of operation 5
2.1	Accessories 6
2.2	Technical data 7
2.3	LED blinking pattern 8
3	Connection to the valve 11
3.1	Mounting position 11
4	Electrical connection 12
5	Dimensions in mm 16
6	Function description – List of function blocks in TROVIS-VIEW 18
7	Setting and operation with TROVIS-VIEW 22
7.1	General 22
7.1.1	System requirements 22
7.2	Installing TROVIS-VIEW 22
7.3	Starting TROVIS-VIEW and performing settings 23
7.4	Reading the operating status 26
7.5	Changing the user level 26
7.6	Configuration 28
7.6.1	Parameter settings 29
7.7	Operating values 30
7.8	Diagnostics 31
7.8.1	Additional diagnostics in Specialist user level 35
7.9	Operational data graphs (Trend Viewer) 36
8	Data transmission 38
8.1	Data transmission between TROVIS-VIEW and the device (connecting cable) 39
8.1.1	Offline operation (indirect data transmission) 40
8.1.2	Online operation (direct data transmission) 40
8.2	SAMSON memory pen 41
8.2.1	Data transmission between TROVIS-VIEW and memory pen 41
8.2.2	Data transmission between the actuator and memory pen 43
8.2.3	Copy function 44
8.2.4	Command mode 44
8.2.5	Data logging 45
9	Configuration list and customer data 48
	Index 53

1 General safety instructions

For your own safety, follow these instructions concerning the mounting, start up and operation of the electric actuator with process controller:

- ▶ Mounting, start-up and operation of this device may only be performed by trained and experienced personnel familiar with the product.
According to these Mounting and Operating Instructions, trained personnel refers to individuals who are able to judge the work they are assigned to and recognize possible hazards due to their specialized training, their knowledge and experience as well as their knowledge of the applicable standards.
- ▶ Any hazards which could be caused in the connected valve by the process medium, operating pressure or moving parts are to be prevented by means of the appropriate measures.
- ▶ The actuators has been designed for use in electrical power installations.
For wiring and maintenance, you are required to observe the relevant safety regulations. The actuator must be protected against unintentional reconnection of the power supply.
- ▶ Before wiring the electric actuator, disconnect it from the power supply.

To avoid damage to any equipment, the following also applies:

- ▶ Proper transportation and storage are assumed.

2 Design and principle of operation

The Type 5757-3 Electric Actuator with Process Controller is an electric actuator with an integrated digital controller. It can be mounted onto SAMSON Type 3222, Type 3222 N, Type 2488 and Type 3267 Valves (DN 15 to 25) and onto special versions of Type 3260 and Type 3226 Valves.

The electric actuator with process controller has an input for a Pt 1000 temperature sensor. It can function as a fixed set point controller with this input.

Alternatively, the electric actuator can be used for domestic hot water in instantaneous heating system. In this case, either a flow rate sensor or a flow switch must be used. The flow switch recognizes when the hot water is being tapped. The flow rate sensor can additionally record the quantity of hot water being tapped. An optimization function adapts the control to the changing network conditions.

In addition to the temperature sensor input, the electric actuator has a current input. This can be used in place of the temperature sensor or to connect an external set point. In actuators with switching output (firmware version 2.0x/2.1x) the switching output can be configured as a pump output (circulation pump for DHW circuit or heating circuit), a fault alarm output or an indication output for the tapping function.

The set point of the digital controller is set to 60 °C and can be changed in TROVIS-VIEW using a connecting cable connected to the RS-232 interface (serial interface) on the actuator or using a memory pen.

The controlled variable, control behavior and operating direction of the actuator can also be changed in TROVIS-VIEW.

The output signal of the process controller is issued as a three-point stepping signal to the synchronous motor of the actuator and is transferred over the connected gear to the actuator stem (3) to stroke the valve. The motor is switched off by torque-dependent switches when an end position is reached or in case the motor is overloaded.

The actuator is mounted onto the valve using a coupling nut (4).

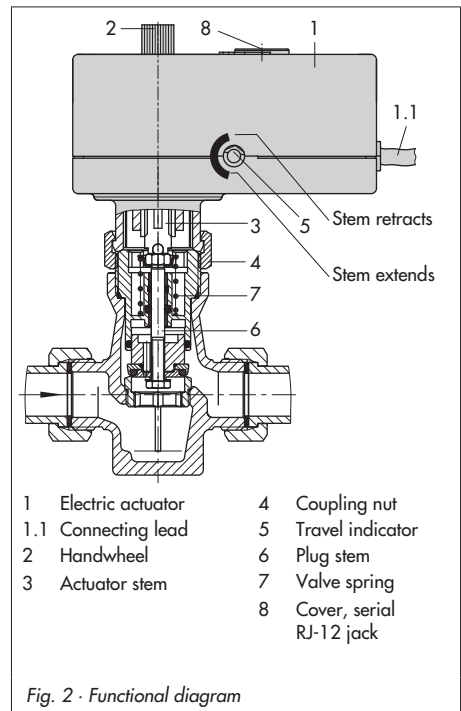

When the actuator stem extends, the globe valve is closed, opposing the force of the valve spring (7, Fig. 2). When the actuator stem retracts, the valve is opened as the plug stem (6) follows the motion of the return spring

When connected to a three-way mixing valve, the extending actuator stem causes the valve (**A** → **AB**) to open.

The valve can be moved to any position when the **power supply is disconnected** by the handwheel (2, Fig. 2).

Travel and direction of action can be read off the travel indicator (5) at the side.

2.1 Accessories

Accessories for communication:

TROVIS-VIEW Software (6661-1062) is required, see section 7.

Accessories for domestic hot water in instantaneous heating systems:

Type 5207-0060 Temperature Sensor

Fast-responding Pt 1000 sensor, see Fig. 7, page 16/17.

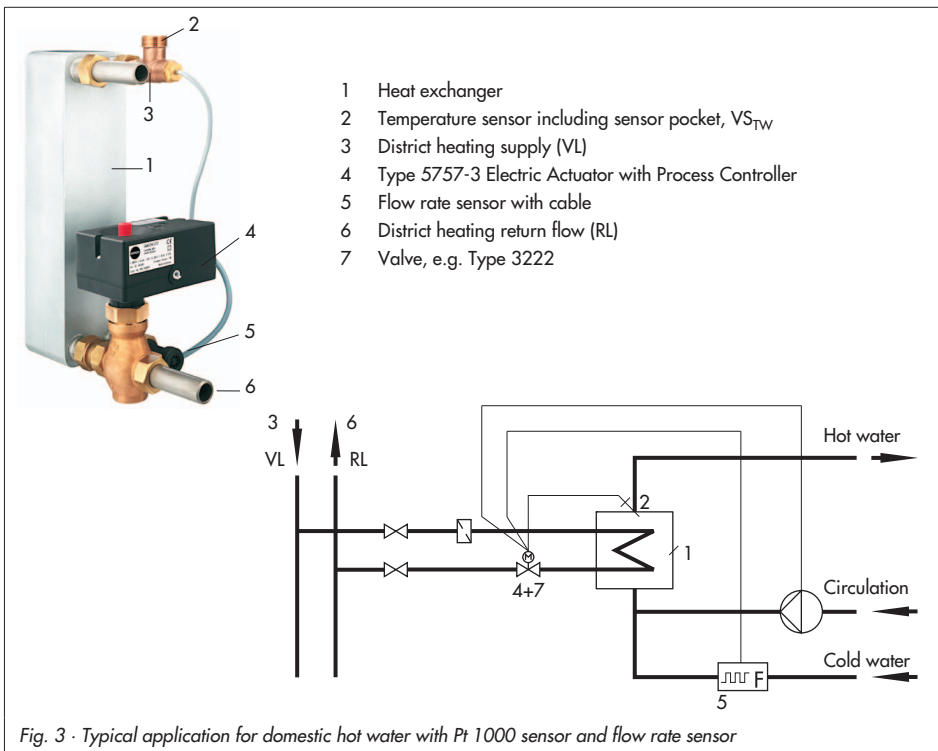

Fig. 3 · Typical application for domestic hot water with Pt 1000 sensor and flow rate sensor

Sensor pocket

To provide the best positioning of the Pt 1000 sensor at the heat exchanger, see Fig. 7, page 16/17.

Order no. 1400-9249

Flow rate sensor with extension cable

Axial turbine flowmeter, see Fig. 7, page 16/17.

Order no. 1400-9246

Type 5757-3 Electric Actuator with Process Controller	
Rated travel	6 mm
Transit time for rated travel	20 s
Nominal thrust	300 N
Supply voltage	230 V ($\pm 10\%$) / 50 Hz
Power consumption	Approx. 3 VA
Class of protection	II according to EN 61140
Perm. ambient temperature	0 to 50 °C
Perm. storage temperature	-20 to 70 °C
Degree of protection	IP 42 according to EN 60529
Mounting position	Any, but not suspended
Electromagnetic compatibility	According to EN 61000-6-2, EN 61000-6-3 and EN 61326
Weight	Approx. 0.7 kg
Binary input BE1 ¹⁾	Set point switchover
Binary input BE2 ¹⁾	Flow switch
Version with switching output (firmware version 2.0x/2.1x)	
Switching output	230 V, 50 Hz, max. 1 A
Additional electrical equipment	
Temperature sensor	Pt 1000: -50 to 150 °C
Flow rate sensor	530 pulse/l
Flow switch	Floating contact
Control input	0/4 to 20 mA

¹⁾ Recommended: Use devices with gold contacts when using relays

2.3 LED blinking pattern

The actuator has a red and a yellow LED which indicate the operating state of the actuator. The LEDs are located underneath the cover on top of the actuator.

Blinking pattern of the yellow LED

- Device switched off or no communication with memory pen or command pen inserted



- Device switched on or memory pen inserted: Memory pen action completed (see section 8.2.2)



- Memory pen inserted: Preparing to read from memory pen (see section 8.2.2)

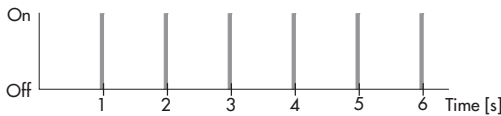

- Memory pen inserted: Preparing to write data to memory pen (see section 8.2.2)

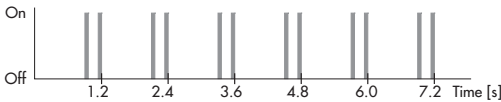

- Memory pen inserted: Validity error in memory pen

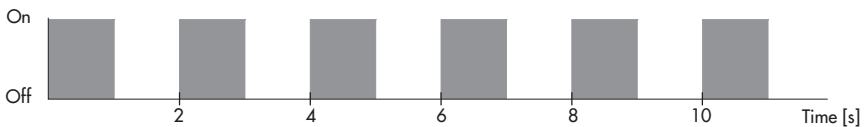

- Memory pen inserted: EEPROM error in memory pen

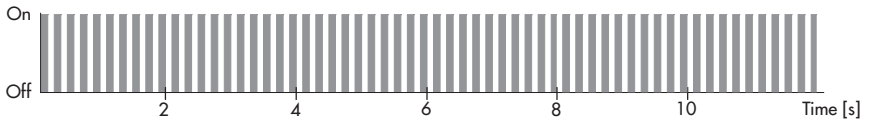

Blinking pattern of the red LED

- Normal operation or memory pen inserted



- Device is starting up after a reset has been performed or limit switch error



- Temperature too high (upper limit value GWH exceeded)

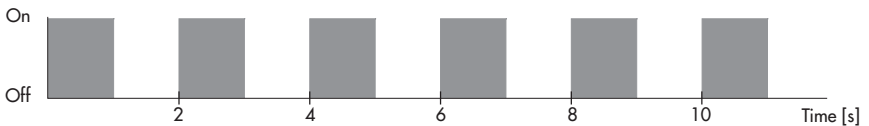

- EEPROM error in device

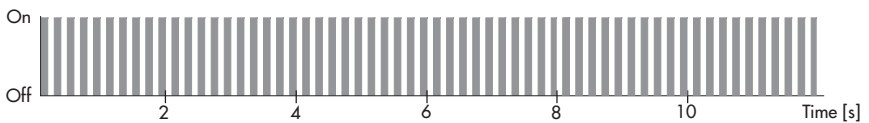

- Zero calibration in progress

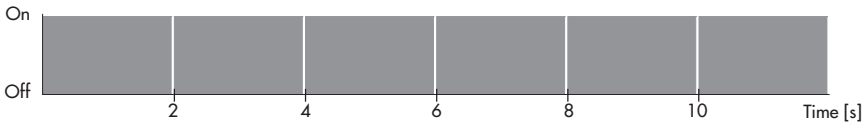

- Transit time measurement in progress

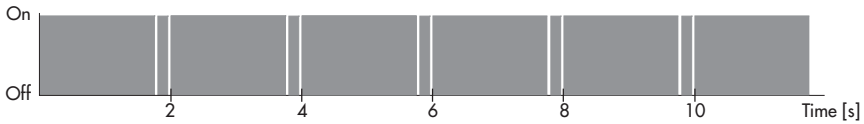

- Wire breakage at temperature input



- Wire breakage at current input



- Flow rate at flow rate sensor exceeds measuring range

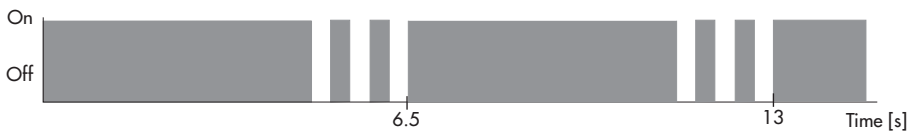

3 Connection to the valve

The actuator has a force-locking connection to the valve when the power supply is disconnected.

- ▶ Turn the handwheel (2, Fig. 2) counter-clockwise to retract the actuator stem as far as it will go.
- ▶ Place the actuator on the valve connection and screw coupling nut (4, Fig. 2) tight (tightening torque 20 Nm).

3.1 Mounting position

Any mounting position may be used, however, the actuator may not be installed in a suspended position.

4 Electrical connection



Risk of electric shock!

When installing electric cables, you are required to observe the regulations governing electrical power plant installation according to DIN VDE 0100 as well as the regulations of your local power supply company.

Use a suitable power supply which guarantees that no dangerous voltages reach the device in standard operation or in the event of a fault in the system or in any other system parts.

Connect the actuator to the electrical network only after the power supply is first switched off. Make sure the power cannot be switched on unintentionally!

For the actuator to function, a Pt 1000 temperature sensor must be connected.

The binary input can be used to change between the two set points W1 and W2.

Alternatively, instead of the Pt 1000 sensor, the current input 0/4 to 20 mA can be used for control purposes.

In addition, a flow rate sensor or a flow switch can be connected to quickly recognize when domestic hot water is being tapped.

Connect the ends of both connecting leads as shown in Fig. 4 and Fig. 5 (page 13 onwards).

Insulate any wires that are not used.

Note:

The initialization process starts immediately after the actuator has been connected to the electrical power supply.

The actuator stem extends (when the direction of action increasing/increasing has been set) and the red and yellow LEDs on top of the actuator light up.

The red LED goes out as soon as the actuator stem has reached the end position.

The yellow LED continues to light up and indicates that the electric actuator is ready for operation.

Error indication:

A wire breakage at the temperature input or at the current input is indicated by a slowly blinking red LED. Refer to section 2.3.

Note: A faulty sensor line cannot be detected when a 0 to 20 mA input signal is used.

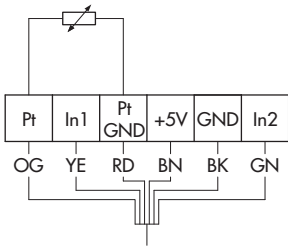

Operation with Pt 1000 sensor
(switching output L' as pump output)

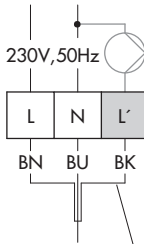

WARNING!
Live wire

Note:

The gray shaded terminal L' only exists in the version with switching output (firmware version 2.0x/2.1x).

- 1) Flow rate sensor (WSS)
- 2) Flow switch

- OG orange
- YE yellow
- RD red
- BN brown
- BU blue
- GN green
- BK black
- WH white

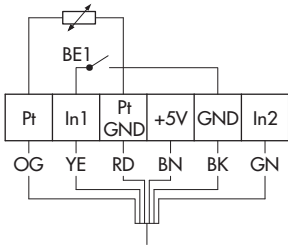

Operation with Pt 1000 sensor and binary contact to determine the set point
(switching output L' as pump output)

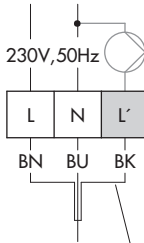

WARNING!
Live wire

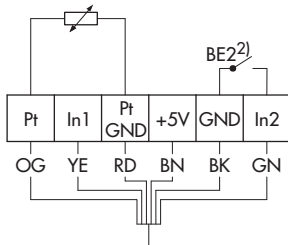

Operation with Pt 1000 sensor and flow switch
(switching output L' as pump output)

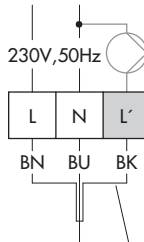

WARNING!
Live wire

Fig. 4 - Wiring diagram (part 1)

Note: Terminals at the point of installation, not included in scope of delivery

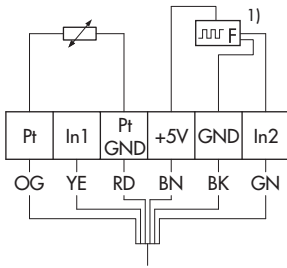

Operation with Pt 1000 sensor and flow rate sensor

(switching output L' as pump output)

Refer to Fig. 6 for details on wiring of flow rate sensor

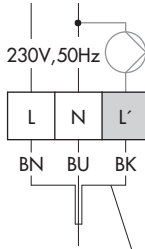

WARNING!
Live wire

Note:

The gray shaded terminal L' only exists in the version with switching output (firmware version 2.0x/2.1x).

- 1) Flow rate sensor (WSS)
- 2) Flow switch

- OG orange
- YE yellow
- RD red
- BN brown
- BU blue
- GN green
- BK black
- WH white

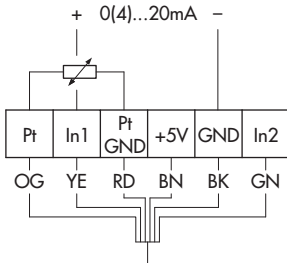

Operation with Pt 1000 sensor and external set point over current signal

(switching output L' as pump output)

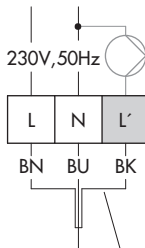

WARNING!
Live wire

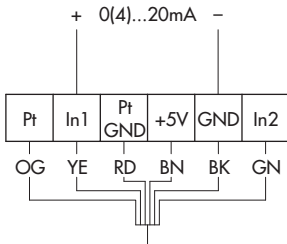

Operation with current signal (actual value)

(switching output L' as pump output)

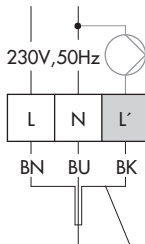

WARNING!
Live wire

Fig. 5 · Wiring diagram (part 2)

Note: Terminals at the point of installation, not included in scope of delivery

Wiring of flow rate sensor (WSS)

WSS	Extension cable	Type 5757-3
GND BK	— BN	— BK GND
Signal GN	— GN	— GN Signal
5 V WH	— WH	— BN 5 V

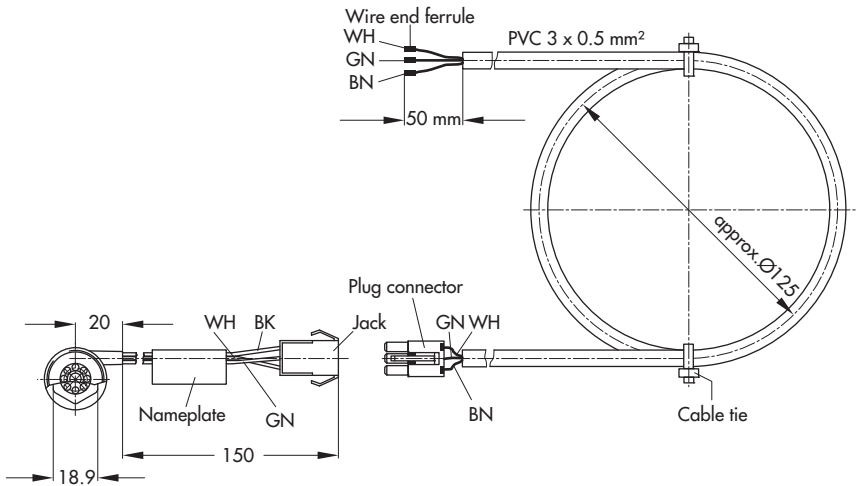
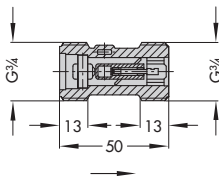
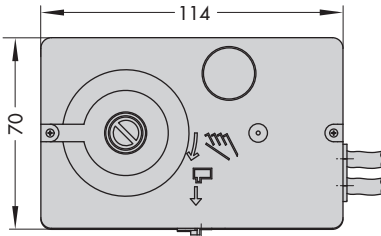
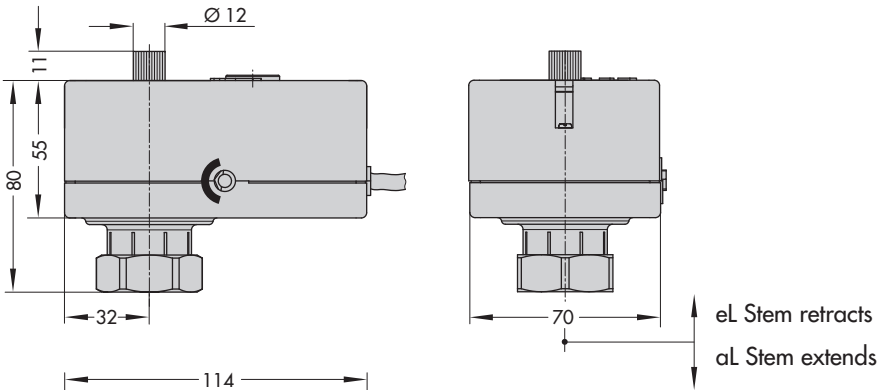

Fig. 6 · Wiring of flow rate sensor (WSS)

5 Dimensions in mm



Flow rate sensor with extension cable
(order no. 1400-9246)

Measuring range: 1 to 30 l/min,
DN 10, PN 10, IP 54
max. medium temperature: 70 °C
Extension cable length: 2 m

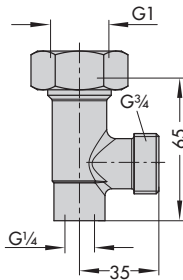

Sensor pocket (incl. gasket)
for heat exchanger with G 1
(order no. 1400-9252)

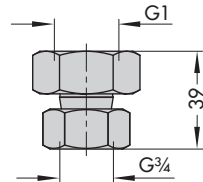

Connecting piece (incl. gasket)
for valve G 1
(order no. 1400-9237)

Fig. 7 · Accessories

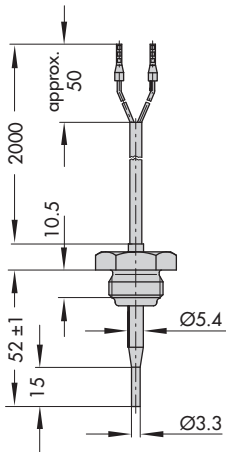

Type 5207-0060 Pt 1000 Sensor

Response times: $t_{0,5} < 1$ s,
 $t_{0,9} < 3$ s; in water 0.4 m/s
 PN 16

max. medium temperature: 90 °C

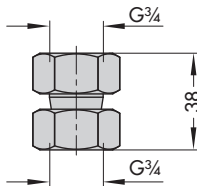

Connecting piece (incl. gasket)
 for valve G $\frac{3}{4}$
 (order no. 1400-9236)

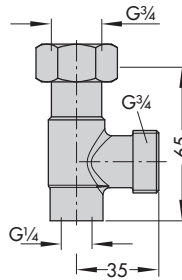

Sensor pocket (incl. gasket)
 for heat exchanger with G $\frac{3}{4}$
 (order no. 1400-9249)

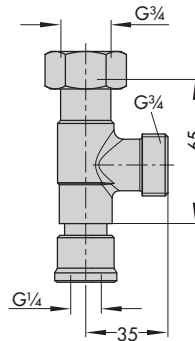

Circulation circuit connection (incl. gasket)
 (order no. 1400-9232)

6 Function description – List of function blocks in TROVIS-VIEW

The functions listed in the *Configuration* folder are explained in detail in the following table.

F = Function block WE = Default setting

F	Function	WE	Description
01	DHW tapping recognition	1	<p>0 – Continuous control The actuator functions following the sensor signal</p> <p>1 – Flow sensor active Actuator is activated when DHW tapping is recognized and finishes control when tapping is ended (Exception: Maintaining exchanger at constant heat is active)</p>
			<p>The fast recognition of DHW tapping is essential for domestic hot water in instantaneous heating systems since the device then immediately receives information as soon as hot water is tapped and when tapping is finished.</p> <p>As an option to the standard equipment, the device can be combined with a flow switch or a flow rate sensor:</p> <p>The flow switch records the tapping and passes on this information as a binary signal to the device.</p> <p>The flow rate sensor records the amount of hot water being tapped and issues the momentary flow rate to the device.</p>
02	Flow sensor	1	<p>Only active when F 01 – 1</p> <p>0 – Flow switch 1 – Flow rate sensor</p>
03	Adaptation	1	<p>Only active when F 01 – 1</p> <p>0 – Passive 1 – Active (only when F 01 – 1 and F 02 – 1)</p>
			<p>NOTICE: The Adaptation function does not have any effect on the control parameter settings!</p>

F	Function	WE	Description
04	Operating direction	0	0 – Increasing/increasing 1 – Increasing/decreasing
			<p>Increasing/increasing: When actual value is lower than the set point: Actuator stem retracts Increasing/increasing: When actual value is higher than the set point: Actuator stem extends Increasing/decreasing: When actual value is lower than the set point: Actuator stem extends Increasing/decreasing: When actual value is higher than the set point: Actuator stem retracts</p> <p>Actuator stem retracting: Globe valve opens Three-way valve closes port A → AB and opens port B → AB</p> <p>Actuator stem extending: Globe valve closes Three-way valve opens port A → AB and closes port B → AB</p>
05	Current input	0	0 – Passive (binary input) Switchover between internal set points W1 and W2 by activating the binary input 1 – Active: Current input active
06	Function of current input	0	Only active when F 05 – 1 0 – Actual value Input variable is the measured value, Pt 1000 input inactive! 1 – Set point: Input variable is the external set point, Pt 1000 input is the controlled variable
			<ul style="list-style-type: none"> • Actual value: The measured input signal (mA) is in relation to the measuring range. The Pt 1000 input is not active. • External set point: This is compared with the temperature measured by the Pt 1000 sensor and the deviation used for the control. Both set point and Pt 1000 signal are in relation to the measuring range.
07	Measuring range of current input	0	Only active when F 05 – 1 0 – 0 to 20 mA 1 – 4 to 20 mA

Function description – List of function blocks in TROVIS-VIEW

F	Function	WE	Description
08	Function of binary input	0	<p>Only active when F 05 – 0</p> <p>0 – End maintain temperature constant in heat exchanger When the binary input is active, maintain temperature constant OFF</p> <p>1 – Switchover between internal set points</p> <p>Binary input open: W1 is the set point Binary input closed: W2 is the set point</p>
			<p>Depending on the configuration, the binary input is used to switchover between the two internal set points or to end maintaining temperature constant in the heat exchanger. The internal set points can be used, for example, for DHW heating and also for thermal disinfection.</p>
09	Maintaining exchanger at constant heat	0	<p>0 – Time adjustable (only active when F 01 – 1)</p> <p>1 – Continuous</p>
			<p>If the device is equipped with a tapping recognition, the heat exchanger can be kept at a constant temperature by this setting. This means that the heat exchanger is maintained to a defined reduced temperature compared to the set point W1 over an adjustable period of time since the last time water was tapped.</p> <p>NOTICE: An active constant temperature maintaining feature is ended upon failure of the power supply. After reconnecting the power supply, hot water must be tapped to reactivate the constant temperature maintaining feature.</p>
10	Upper limit value GWH	0	<p>0 – No limitation</p> <p>1 – Y is set to 0 % when GWH is exceeded</p>
			<p>Excessive temperature protection: When the temperature exceeds GWH limit, the valve is closed until the temperature falls below GWH limit minus hysteresis.</p>
11	Lower limit value GWL	0	<p>0 – No frost protection</p> <p>1 – Frost protection starts when temperature falls below GWL</p>
			<p>Frost protection: When the temperature falls below GWL limit, the valve is controlled to move in the opening direction until the temperature exceeds GWH limit plus hysteresis.</p>

F	Function	WE	Description
Version with switching output			
Firmware version 2.0x			
13	Function of switching output	0	Only active when F 15 – 1 0 – Pump control 1 – Fault indication
14	Pump control	0	Only active when F 13 – 0 and F 15 – 1 0 – Circulation pump (DHW circuit) 1 – Circulation pump (heating circuit)
15	Switching output	0	0 – Passive 1 – Active
	<p>The switching output can only be used when it is active (F15 – 1). Otherwise, the settings of function block F13 and F14 are ineffective.</p> <p>WARNING! The additional wire of the supply line (BK) may be live when the switching output is active.</p>		
Firmware version 2.1x			
16	Function of switching output	1	1 – Passive 2 – Fault indication 3 – Circulation pump (DHW circuit) 4 – Circulation pump (heating circuit) 5 – Tapping
	<ul style="list-style-type: none"> • Fault indication: Immediately after a fault arises (e.g. wire breakage in the sensor cable or violation of the temperature range), the switching output becomes active. • Circulation pump (DHW circuit): The switching output is either constantly active or active for the adjustable period of time. • Circulation pump (heating circuit): The switching output is active while the actuator stem is not in the end position for “stem extended”. • Tapping: The switching output is active while hot water is being tapped. <p>WARNING! The additional wire of the supply line (BK) may be live when the switching output is active.</p>		

7 Setting and operation with TROVIS-VIEW

7.1 General

The TROVIS-VIEW Software allows various smart SAMSON devices to be configured over a common user interface. It consists of the user interface, communication server and the device-specific module. The software has a Windows® Explorer look and feel.

The entire configuration of the electric actuator with process controller can be performed using the TROVIS-VIEW Software.

TROVIS-VIEW is available on the SAMSON website (Services > Software > TROVIS-VIEW).

Note: The following instructions include a description of the key functions of TROVIS-VIEW in conjunction with the device. Refer to the online help in the ? menu for a detailed description.

7.1.1 System requirements

Hardware

- ▶ PC with Pentium processor or equivalent processor (300 MHz or higher), 500 MHz recommended
- ▶ Serial interface or USB/RS-232 adapter
- ▶ Min. 96 MB RAM, more than 192 MB RAM recommended
- ▶ Min. 150 MB free hard disk space plus approx. 15 to 30 MB additional hard disk space per SAMSON module

Software

- ▶ Operating system: Windows® 2000 SP2, Windows® XP, Windows® Vista, Windows® 7
- ▶ Microsoft® .NET Framework Version 2.0 or higher (included on installation CD-ROM)
- ▶ Internet browser: Microsoft® Internet Explorer 6.0 or higher
- ▶ PDF reader

7.2 Installing TROVIS-VIEW

1. Run setup.exe to start installation.
-

Note on installation using the downloaded file:

Unzip the downloaded file before starting installation.

Note on installation using the installation CD-ROM:

Depending on the settings of your operating system, installation is started automatically when the CD-ROM is inserted, i.e. the setup.exe file does not need to be started manually.

2. Follow the on-screen prompts and instructions of the installation program.

7.3 Starting TROVIS-VIEW and performing settings

You can perform the settings in TROVIS-VIEW either when the device is connected (online) to the computer or not connected (offline). Refer to section 8.

Note: When the device is not connected, the default settings appear on the user interface or, alternatively, a saved TROVIS-VIEW file (*.tro) can be loaded and overwritten by selecting Open in the File menu.

1. Start TROVIS-VIEW.

The user interface appears on screen.

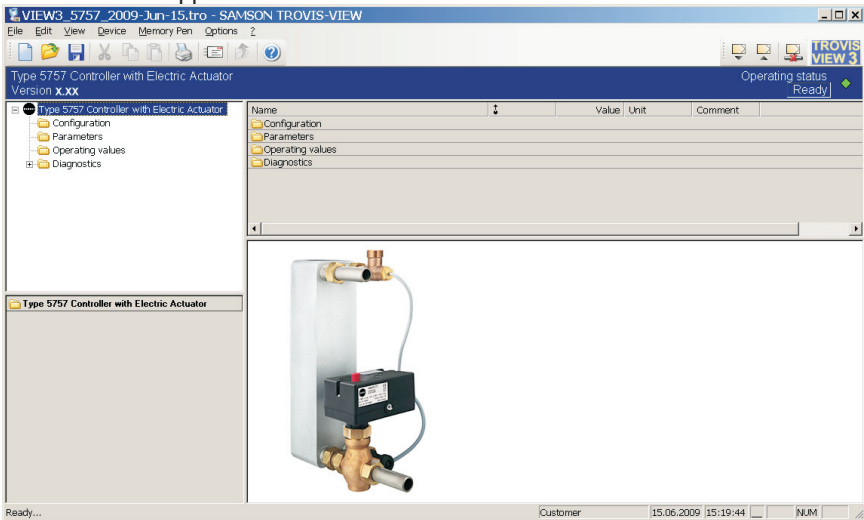

You can read key information on this screen:

Online/offline mode: The **TROVIS VIEW 3** icon on the onlinebar is animated in online mode (see section 8.1.2).

Operating status: The current operating status is indicated on the right-hand side of the info bar (see section 7.4).

User level: The active user level (customer or specialist) is indicated on the status bar (see section 7.5).

- In *View* menu, select required settings for the user interface.
All options are checked in the default setting of this menu.
Uncheck individual options as required.

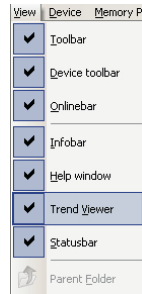

- In *Options* menu, select *Language* to change the interface language.
Note: Grayed languages are not available and cannot be selected.
You can select a different language at any time.
TROVIS-VIEW switches directly to the selected language.

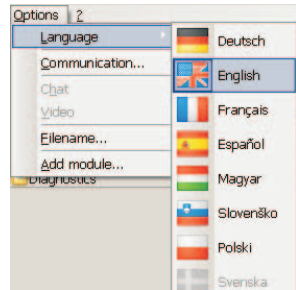

- If required, create the TROVIS-VIEW file name in *Options* menu from the type, date and selectable parameters. The created file name can be previewed before saving it (e.g. VIEW3_5757_2009-Jun-09.tro).

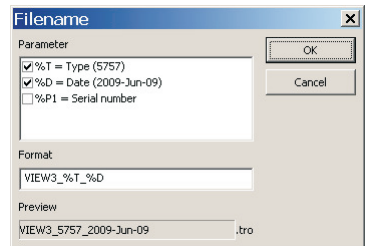

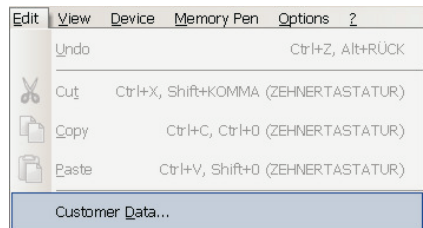

- If required, select *Customer data* in *Edit* menu to enter data relevant to the plant, e.g. project name, plant location, user.
- If required, select *Load Factory Defaults* in *Edit* menu if you want to load default settings onto the user interface.



7.4 Reading the operating status

The current operating status is indicated on the right-hand side of the infobar.

The *Diagnostics* folder contains more details on errors (see section 7.8).

Operating status	Icon
Ready	
Error	

7.5 Changing the user level







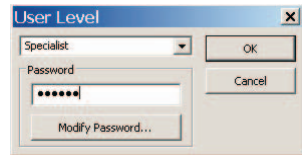



Note: *The user level can only be changed in offline mode.*

1. Select *User Level* in *Device* menu.
2. Select "Specialist" from drop-down list.
3. Enter password. This password is "samson" in the delivered state.

Click *Modify Password* button to open the window where you can change the password.



Properties of data points are indicated by icons when clicking on a folder:

Icon	Meaning
	Data cannot be changed
	Data can be changed
	Data point can be executed
	Data point is user-defined
	Mark to indicate status/error
	Value has exceeded maximum limit
	Value has fallen below minimum limit
Source of data:	
	Value has been modified manually
	Value has been uploaded from the device. In online mode, X in the icon indicates a value has been updated.
	Value originates from a saved file
	Value adopted from memory pen

7.6 Configuration

Note: Section 6 contains descriptions on the functions and parameters.

1. Click *Configuration* folder.

The individual functions appear together with their current settings (I/O).

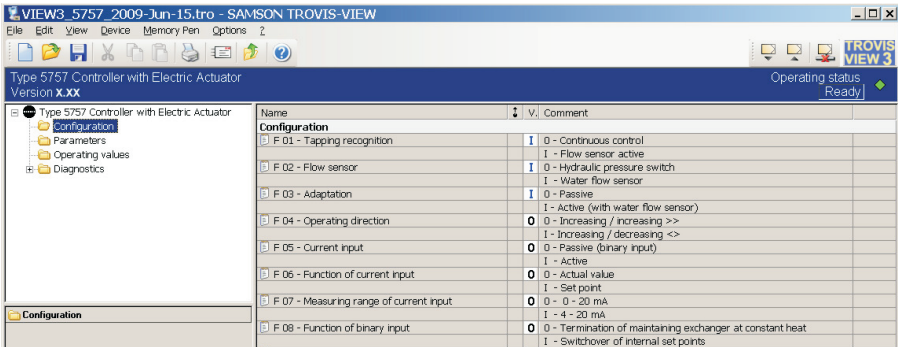

2. Change settings:

Double-click the required function setting to change the function value (I/O).

Right-click the required function to open pop-up window to modify function settings.

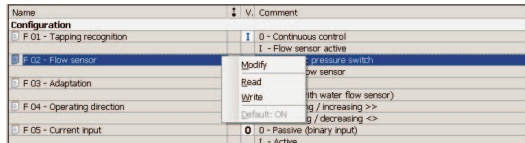

- [Modify] Opens pop-up window to modify function block setting.
- [Read] Uploads the function block setting from the device. Display only in offline mode (see section 8.1.1).
- [Write] Downloads the function block setting to the device. Display only in offline mode (see section 8.1.1).
- [Default: ...] Resets function to default setting (setting in gray to indicate that the status of function is the same as the default setting)

7.6.1 Parameter settings

1. Click *Parameters* folder.

The parameters appear together with their current settings.

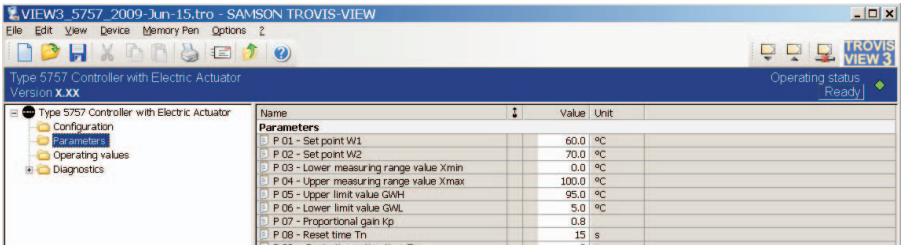

2. Change settings:

Double-click the required parameter to open pop-up window to modify parameter settings.

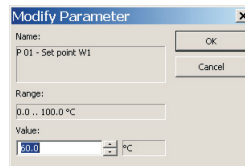

Right-click the required parameter to open pop-up window to modify parameter settings:

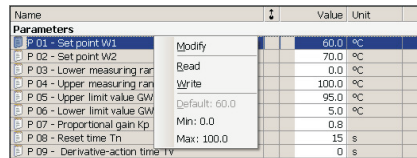

- [Modify] Opens pop-up window to modify parameter settings.
- [Read] Uploads the parameter value from the device.
Display only in offline mode (see section 8.1.1).
- [Write] Downloads the parameter value onto the device.
Display only in offline mode (see section 8.1.1).
- [Default: ...] Resets function to default setting (setting in gray to indicate that the status of function is the same as the default setting).
- [Min ...] Set parameter to the displayed minimum value (value in gray to indicate that the parameter value is the same as the minimum value).
- [Max...] Set parameter to the displayed maximum value (value in gray to indicate that the parameter value is the same as the maximum value).

7.7 Operating values

Note: The values in Operating values folder cannot be changed.

In **online mode** (animated  icon) the current operating values are displayed.

- Firmware version 1.0x and 2.0x

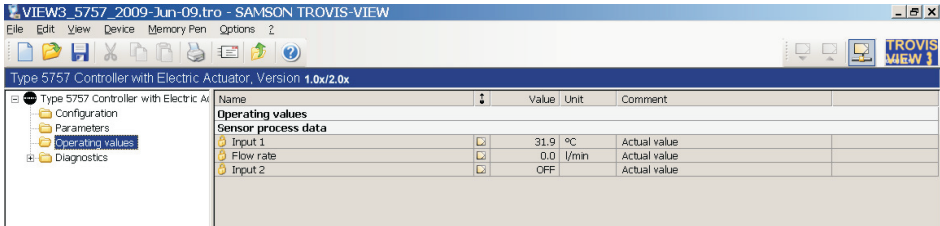

Name	Value	Unit	Comment
Operating values			
Sensor process data			
Input 1	31.9	°C	Actual value
Flow rate	0.0	l/min	Actual value
Input 2	OFF		Actual value

- Firmware version 2.1x

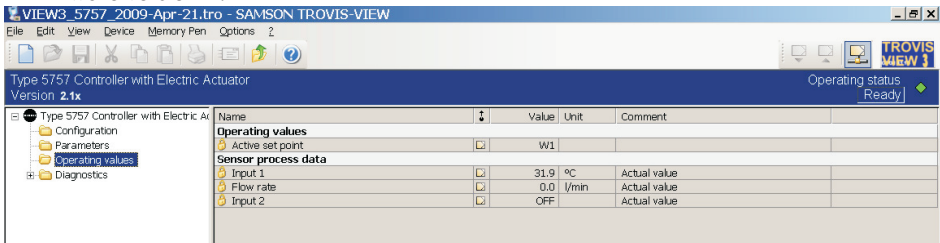

Name	Value	Unit	Comment
Operating values			
Active set point			
Active set point	W1		
Sensor process data			
Input 1	31.9	°C	Actual value
Flow rate	0.0	l/min	Actual value
Input 2	OFF		Actual value

Note: The user level is set to “Customer” by default in TROVIS-VIEW. The current user level is displayed on the status bar. When the user level is set to “Specialist”, additional information on the stem position (retracted/extended/calculated stem position), switching output and the device inside temperature are displayed.

Change the user level to “Specialist” by selecting User Level in Device menu (see section 7.5).

7.8 Diagnostics

The *Diagnostics* folder is subdivided into the areas *Information*, *Errors*, *Manual level*, *Status messages* and *Statistics*.

Information

Name	Value
Diagnostics - Information	
Device	
Firmware version	2.10
Serial number	-1
Identification	
Device information	5757, 2.10 (448)
Manufacturing parameter	?

Errors

Name	Comment	
Diagnostics - Errors		
State		
Malfunction		
Actions		
Zero calibration in progress		
Sensor rupture		
Temperature input		
Current input		
Exceptional error		
Upper limit value GWH exceeded		
Flow rate exceeds measuring range		
Both limit switches ON		
Canceled while retracting stem		
Canceled while extending stem		
EEPROM error		
Configuration		
Parameters		
Calibration		
Serial number		
Manufacturing parameter		
Diagnostic data: status messages		
Diagnostic data: statistics		

Note: The state Malfunction, the exceptional errors Canceled while retracting stem and Canceled while extending stem as well as the EEPROM errors Diagnostic data: status messages and Diagnostic data: statistics are only displayed in devices with firmware 2.00 and higher.

Manual level

Name	Value	Unit	Comment
Diagnostics - Manual level			
Enable			
Enable manual level	OFF		Only in online mode
Stem adjustment			
Calculated stem position	0.0	%	
Actuator stem retracts	OFF		
Actuator stem extends	OFF		
Normalized positioning value	0.0	%	
Move stem to normalized positioning value	OFF		
Outputs			
Switching output	OFF		
LED for operation (yellow)	OFF		
LED for error indication (red)	OFF		

The device can be transferred to the manual level in TROVIS-VIEW when the manual level is enabled in online mode (*Enable manual level* parameter = On ( icon)).

When the device is in the manual level, the actuator stem can be moved by using the handwheel (2, Fig. 2).

The following additional actions can be performed in the manual level (firmware version 2.00 and higher):

- ▶ Retract actuator stem
- ▶ Extend actuator stem
- ▶ Move stem to normalized positioning value
The positioning value based on the input variable range (normalized positioning value) must be entered beforehand
- ▶ LED for operation (yellow) = ON
- ▶ LED for error indication (red) = ON

The device exits the manual mode as soon as the manual level is disabled or online mode is deactivated in TROVIS-VIEW.

Status messages

VIEW3_5757_2009-Apr-21.tro - SAMSON TROVIS-VIEW

Type 5757 Controller with Electric Actuator
Version 2.0x/2.1x

Operating status: Ready

Name	Value	Unit	Comment
Diagnostics - Status messages			
Information			
Serial number	-1		
Manufacturing parameter	?		
Firmware version	2.10		
Operation			
Operating hours	190	h	
Operating hours at excess temperature	0	h	
Temperature inside device	27	°C	
Highest temperature inside device	42	°C	
Lowest temperature inside device	20	°C	
Actuator travels			
Motor running time	0	h	
Attempts	5646		
Changes of direction	188		
Valve strokes			
Stroking cycles	44		
LEDs			
Operation (yellow)	ON		Device is ON
Error (red)	OFF		

Note: Only the status of the device is indicated in devices with firmware version 1.0x.

Statistics

VIEW3_5757_2009-Apr-21.tro - SAMSON TROVIS-VIEW

Type 5757 Controller with Electric Actuator
Version 2.0x/2.1x

Operating status: Ready

Name	Value	Comment
Diagnostics - Statistics		
Counter: device failures		
Power ON	47	
Program interruptions	0	
Limit switch error	0	
EEPROM error	0	
Counter: alarms		
Sensor rupture, temperature input	47	
Sensor rupture, current input	20	
Flow rate exceeds measuring range	2	
Upper limit value GWH exceeded	3	
Inputs and outputs counter		
Binary input ON	0	
Switching output ON	0	
Counter: memory pen		
Command: retract stem	7	
Command: extend stem	1	
Read data	18	
Write data	3	
Log data	1	
Counter: communication		
Configuration changed	100	
Parameters changed	42	
Manual level activated	5	
Zero calibration started	0	
Reset triggered	0	
Default settings loaded	0	
Transit time measurement started	0	

Note:

- The Statistics level is only available for devices with firmware version 2.00 and higher.
- The number of switching operations performed by the binary input and the switching output is only logged in devices with firmware version 2.10 and higher.

7.8.1 Additional diagnostics in Specialist user level

The default user level in TROVIS-VIEW is “Customer”. The current user level is displayed in the status bar. When the user level is switched to “Specialist”, the *Test* and *Calibration* subfolders appear in the *Diagnostics* folder.

Select *User Level* in *Device* menu to change to the Specialist user level (see section 7.5).

Test

The screenshot shows the TROVIS-VIEW software interface. The title bar reads "VIEW3_5757_2009-Jun-09.tro - SAMSON TROVIS-VIEW". The menu bar includes File, Edit, View, Device, Memory Pen, and Options. The status bar indicates "Type 5757 Controller with Electric Actuator" and "Version 2.0x/2.1x". The operating status is "Ready". The left sidebar shows a tree view with folders: Configuration, Parameters, Operating values, Control, Adaptation, Diagnostics, Information, Errors, Test, Manual level, Calibration, and Status messages. The main window displays the "Diagnostics - Test" section with a table of actions:

Name	Value	Unit
Diagnostics - Test		
Actions		
Start zero calibration		
Trigger reset		
Load factory defaults in the device		
Determination of valve transit time		

Note: Zero calibration is not possible in devices with firmware version 1.0x.

Calibration

The screenshot shows the TROVIS-VIEW software interface. The title bar reads "VIEW3_5757_2009-Apr-21.tro - SAMSON TROVIS-VIEW". The menu bar includes File, Edit, View, Device, Memory Pen, and Options. The status bar indicates "Type 5757 Controller with Electric Actuator" and "Version 2.0x/2.1x". The operating status is "Ready". The left sidebar shows a tree view with folders: Parameters, Operating values, Control, Adaptation, Diagnostics, Information, Errors, Test, Manual level, Calibration, Status messages, and Statistics. The main window displays the "Diagnostics - Calibration" section with a table of calibration points:

Name	Value	Unit
Diagnostics - Calibration		
Calibration - input 1		
Measured value	882.9	Digit
Calibration point 1 (1000 Ohm)	600.0	Digit
Calibration point 2 (1500 Ohm)	1739.0	Digit
Calibration - input 2		
Measured value	0.0	Digit
Zero point	103.0	Digit
Final point	1944.0	Digit

Note: The calibration for both inputs is performed at the zero point and final point in devices with firmware version 1.0x.

7.9 Operational data graphs (Trend Viewer)

The Trend Viewer is only displayed when the Trend Viewer is checked [✓] in View menu (see section 7.3).

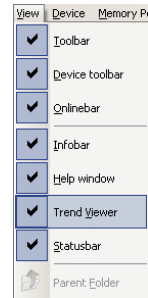

All data of the activated list of parameters are uploaded cyclically from the device in online mode when the Trend Viewer is activated.

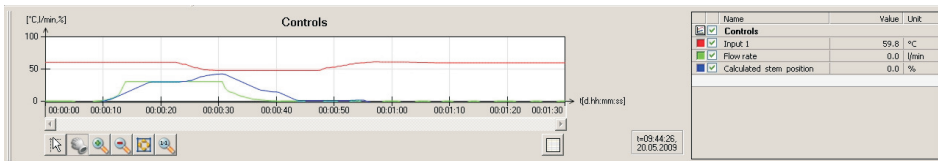

The graph reading can be adapted. The input and/or the travel of the actuator can be displayed if their parameter box is checked.

Besides being able to select the data points, you can shift the x axis and y axis and adapt the scale by moving the crosshair cursor over the graph (reading of changed axis values appear). You can also zoom in and out of the graph.

Click button to list plotted data points in a table and click  button to export the data as a CSV, XML or XLS file. CSV files are text files which can be edited in a text editor, Excel etc. The data points are written in a file in rows separated by a comma.

Performing settings

You can add new data points by dragging and dropping them onto the Trend Viewer window. You can do this by left-clicking on the required data point in the folder. Keep the mouse key pressed down and drag the mouse cursor into the Trend Viewer. You can add a new data point in an existing or a new graph, depending on how the data point is arranged on screen. If required, you can adapt the graph properties by double-clicking or right-clicking (context-sensitive menu) the data point name, range of values, time axis or color. Check or uncheck the data point checkboxes to activate or deactivate individual data points or the whole graph.

Select *Online* in *Device* menu to establish communication and display the selected data points in the Trend Viewer according to the settings previously made.

Apart from merely displaying and exporting the logged data, it is also possible to save the logged data points cyclically in a file. Right-click on the graph and select *Save logging automatically* from the context-sensitive menu to choose a location where the logging should be saved. Select *Modify storage address for logging* from the context-sensitive menu to change this storage location. The logging is automatically saved every five minutes after the online mode is started in a file named using the date, time and module type with the ".log" affix (e.g. Date-Time-Module type.log) as well as when exiting the online mode. This file can be edited as required.

Select online help for more information.

8 Data transmission

The TROVIS-VIEW Software installed on your computer allows you to configure the device either in offline mode (device not connected to a computer) or in online mode (device connected to a computer). To activate the online mode, click  on the device toolbar. The communication port must be set (see section 8.1)

Online mode (direct data transmission)

The device and TROVIS-VIEW are connected constantly in online operation. Current configuration and operating data are uploaded from the device cyclically and displayed in TROVIS-VIEW. The settings configured in TROVIS-VIEW can be directly transferred to the device. To enable communication with the PC, connect the serial interface (COM port) to the serial interface (RJ-12 jack) of the device using a SAMSON connecting cable.

In case the computer does not have a COM port, a USB/RS-232 adapter can be used.

Offline mode (indirect data transmission)

There is no constant data communication between the computer and device. Communication must first be established to upload from the device or download data to the device.

Data can be transferred at the serial interface using the SAMSON connecting cable or using a memory pen together with modular adapter.

A memory pen allows you to simply copy data onto other devices.

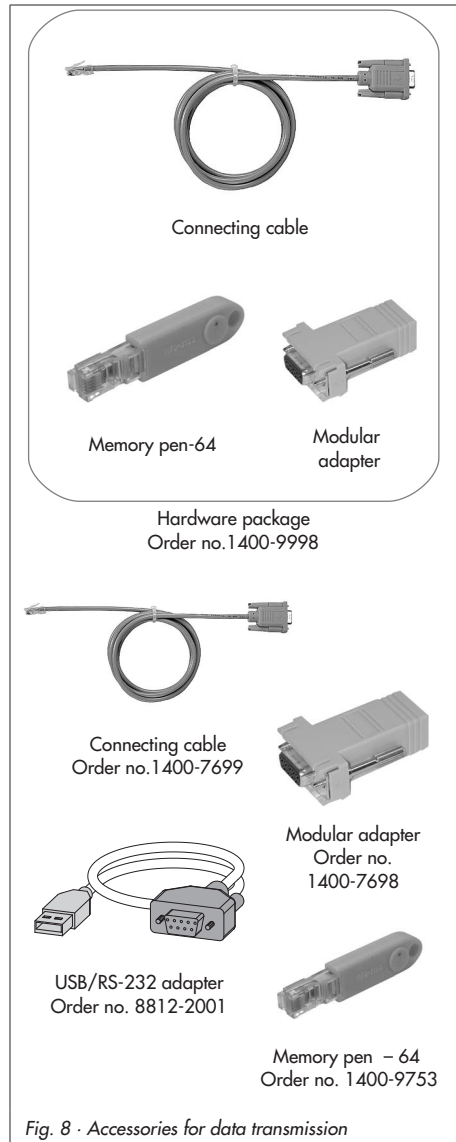

Fig. 8 · Accessories for data transmission

NOTICE

You can only transfer data to the device after the electrical connection has been performed as described in section 4.

8.1 Data transmission between TROVIS-VIEW and the device (connecting cable)

1. Connect the serial port of the computer using the SAMSON connecting cable to the serial interface connection of the actuator.
2. Select *Communications* in *Options* menu to open the server settings window. Click *Server settings* button.
3. Check *Local connection* and *Automatically local connect* boxes and click on OK button to confirm server settings.

The *Communication* window reappears.

4. Click *Port settings* button.
5. The settings window opens and *State: not yet searched* appears in the *Automatic detection* field. Click on *Start* button. TROVIS-VIEW has found the device when *State: Device found on COM* appears, click on *OK* button twice to confirm settings.

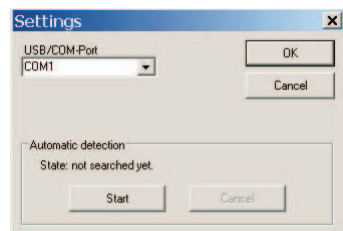
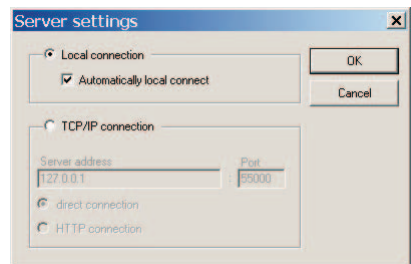
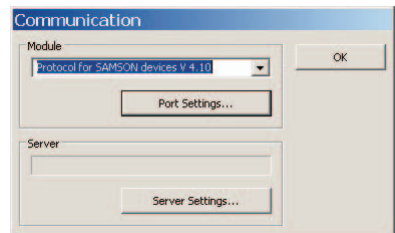

8.1.1 Offline operation (indirect data transmission)



In offline mode, there is no constant data communication between the computer and device. Communication must first be established to upload data from the device and download data to the device.

Downloading data to the device:

Select *Download to the device* in *Device* menu to transfer data to the device. The control task is implemented after data are downloaded from TROVIS-VIEW.

Uploading data from the device:

Select *Upload from device* in *Device* menu to transfer all the data from the device. Uploaded data are indicated in TROVIS-VIEW by the  icon.

Note: Data transmission can also be performed by clicking the icons in the device toolbar: click  to download data from TROVIS-VIEW to the device and click  to upload data from the device and to display them in TROVIS-VIEW.

8.1.2 Online operation (direct data transmission)



The device and TROVIS-VIEW are constantly connected in online operation. Current configuration and operating data are uploaded from the device cyclically and displayed in TROVIS-VIEW. Likewise, any settings performed in TROVIS-VIEW are directly transferred to the device.

Activate online operation:

Select *Online* in *Device* menu to activate online mode. In online mode,  on the toolbar is animated.

Deactivate online operation:

Select *Online* in *Device* menu while the online mode is activated. The online mode is canceled.

Note: Alternatively, click  on the toolbar to activate and click  to deactivate online operation.

8.2 SAMSON memory pen

The SAMSON memory pen serves as a data carrier and is able to load and save data in its non-volatile memory.

The memory pen can be loaded with data configured in TROVIS-VIEW and the settings transferred to one or several device of the same type and version. In the same way, the memory pen can be used to upload data from the device allowing you to simply copy the configuration data from one device to another device of the same type and version.

Operating data can also be recorded with the data logging function (see section 8.2.5).

On inserting a memory pen that is empty or that contains data from another type of device or another version of the same device into the serial interface port of the actuator, the data from the actuator are uploaded to the memory pen regardless of the status of the memory pen and any other data on the memory pen will be overwritten.

Note: Actions and errors of the memory pen are indicated by the **yellow LED**. Refer to section 2.3.

8.2.1 Data transmission between TROVIS-VIEW and memory pen

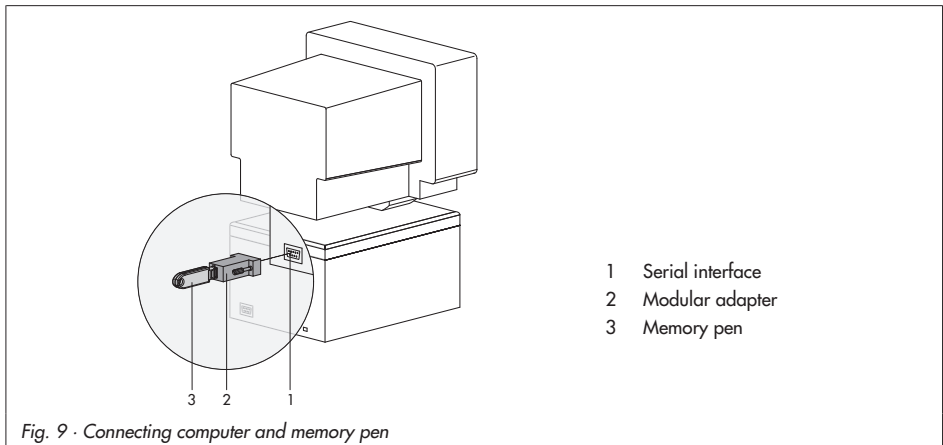

Fig. 9 - Connecting computer and memory pen

1. Plug memory pen (3) together with modular adapter (2) into the serial interface (COM port) of the computer (1) (Fig. 9).
2. Select *Interface* in *Memory Pen* menu.

3. Click *Start* button in *Automatic detection* field of the dialog box.
The computer automatically searches for the interface assigned to the memory pen.
4. Message: "Memory pen found at COM ..."
Confirm interface setting by clicking *OK* button.

Downloading data from TROVIS-VIEW to the memory pen

5. Select *Download to Memory pen* in *Memory pen* menu.
6. Click *OK* button to start data transmission.
7. Click *OK* button to confirm the message "Checking procedure completed. All data of device will be overwritten!"

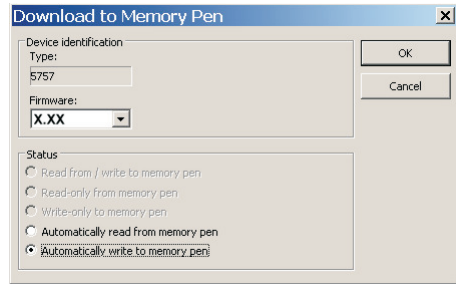

Uploading data from memory pen to TROVIS-VIEW

5. Select *Upload from Memory pen* in *Memory pen* menu to start data transmission.

8.2.2 Data transmission between the actuator and memory pen

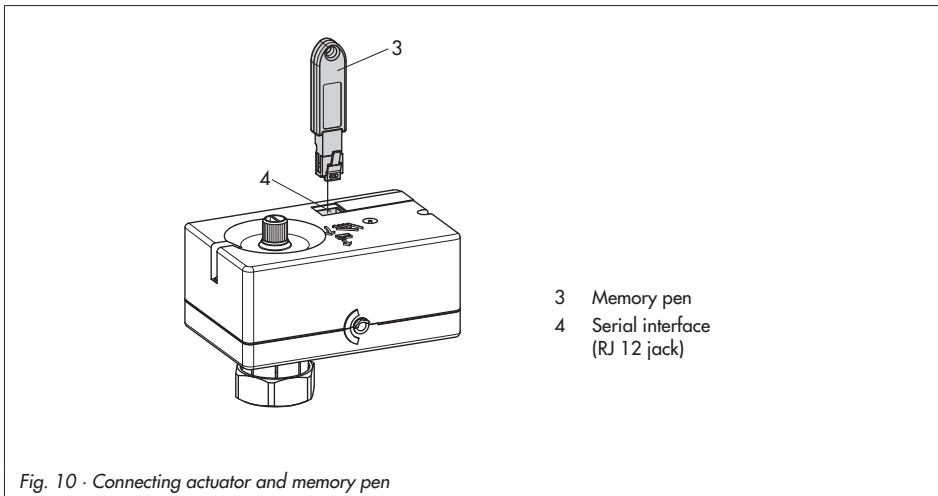

1. Plug memory pen (3) together with modular adapter (2) into the serial interface (COM port) of the computer (1) (Fig. 9).

Uploading data from the actuator to memory pen

2. Select *Modify memory pen status* in *Memory pen* menu.
Check *Automatically write to memory pen* in the dialog box.
Click **OK** button to confirm.
3. Remove memory pen from computer and plug it into the serial interface of the actuator (Fig. 10).

The **yellow LED** on the actuator indicates that data transmission is in progress. Data transmission is completed when the **yellow LED** is illuminated continuously. Remove the memory pen from the actuator.

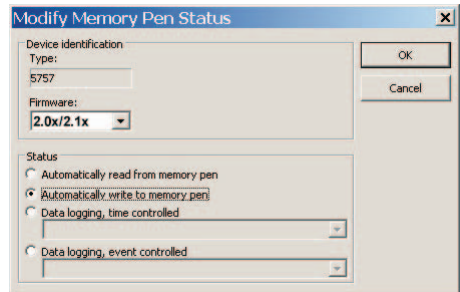
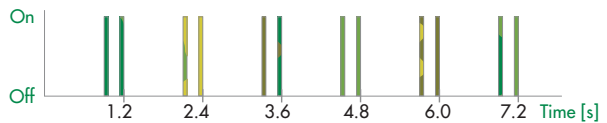

Downloading data from the memory pen to the actuator

2. Select *Modify memory pen status* in *Memory pen* menu.
Check *Automatically read from memory pen* in the dialog box.
Click **OK** button to confirm.
3. Remove memory pen from computer and plug it into the serial interface of the actuator (see Fig. 10).

The **yellow LED** on the actuator indicates that data transmission is in progress. Data transmission is completed when the **yellow LED** is illuminated continuously. Remove the memory pen from the actuator.

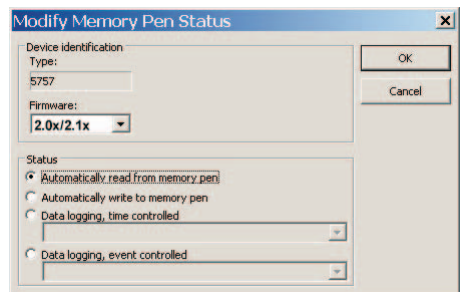
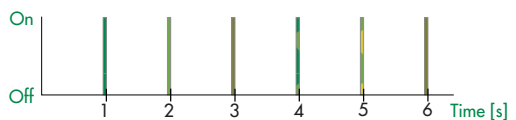

Note: For devices with firmware version 2.00 and higher, data can be logged either time-controlled or event-triggered. To select one of these data logging options, check the option Data logging, time-controlled or Data logging, event-controlled.

8.2.3 Copy function

The memory pen can be used to copy setting data to other Type 5757-3 Electric Actuator with Process Controller as soon as the data from the device have been transferred to the memory pen.

Note: "Automatically write to memory pen" is reset after the first time data are transferred from the device.

8.2.4 Command mode

Note: The command mode can be configured in devices with firmware version 2.00 and higher.

The memory pen is configured to be a command pen in TROVIS-VIEW. The command pen allows the user to move the valve to the open and closed position.

While the actuator is in control operation, the memory pen can be used to transfer the device to the command mode.

Create command pen using TROVIS-VIEW

Note: The extending and retracting of the actuator stem using the command pen is given absolute priority. The actuator does not follow the input signal in this case.

1. Plug memory pen (3) together with modular adapter (2) into the serial interface (COM port) of the computer (1) (Fig. 9).

2. Select *Set command mode* in *Memory pen* menu.
3. Set required action (*Stem retracts* or *Stem extends*).
4. Click *OK* button.
5. Remove memory pen from computer and plug it into the serial interface of the actuator (Fig. 10).
The actuator stem is extended or retracted depending on the setting selected.
6. After removing the memory pen from the actuator, the device returns to normal control operation.

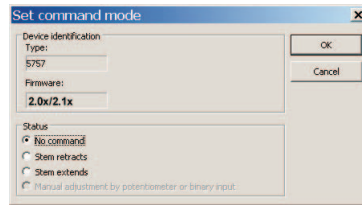

8.2.5 Data logging

Note: The data logging function is only possible for devices with firmware version 2.00 and higher.

The memory pen – 64 allows the following data to be saved:

- ▶ Pt 1000 input
- ▶ Flow rate
- ▶ Current input
- ▶ Stem position
- ▶ Positioning value
- ▶ Disturbance variable Z
- ▶ P component
- ▶ I component
- ▶ D component
- ▶ Malfunction
- ▶ DHW tapping
- ▶ Control
- ▶ Heat exchanger maintained at constant heat
- ▶ Frost protection
- ▶ Switching output
- ▶ Limit switch, stem retracted
- ▶ Limit switch, stem extended
- ▶ Adaptation active
- ▶ Adaptation A1 run

- ▶ Adaptation changed
- ▶ Manual potentiometer
- ▶ Temperature inside the device

The data are logged until the memory capacity of the memory pen is full.

You can save the data on the memory pen in a file (*.log) using TROVIS-VIEW.

Data logging

1. Connect the memory pen to the serial interface of the device (Fig. 10).

The **yellow LED** on the device indicates that data logging is being prepared:

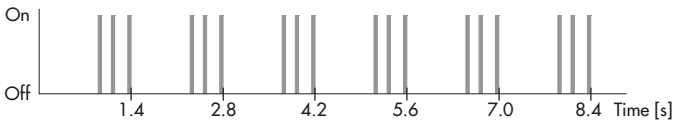

As soon the blinking pattern of the **yellow LED** changes, data transmission to the memory pen is completed.

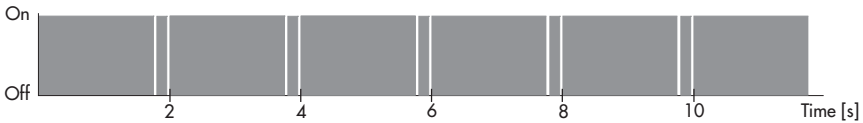

2. Data logging is completed when you remove the memory pen from the serial interface of the device.

Note: You can load a data logging file in the Trend Viewer by selecting Load a graph in the context-sensitive menu.

Transfer logged data onto a computer

1. Plug the memory pen (3) together with the modular adapter (2) into the serial interface (COM port) of the computer (1) (Fig. 9).
2. Select *Upload logged data in Memory pen* menu.
3. Choose target directory.
If the target directory is not changed, data will be saved in the directory SAMSON > Type 5757.
4. Enter a file name.
5. Click *Save* button to start data transmission.

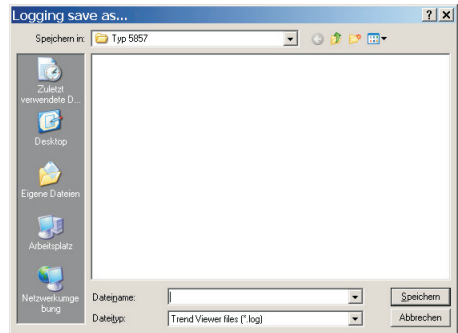

9 Configuration list and customer data

Configuration	Default setting	Setting range	Customer data
Firmware version 1.0x/2.0x/2.1x			
F 01 – DHW tapping recognition	I – Flow sensor active	0 – Continuous control I – Flow sensor active	
F 02 – Flow sensor	I – Flow rate sensor	0 – Flow switch I – Flow rate sensor	
F 03 – Adaptation	I – Active	0 – Passive I – Active	
F 04 – Operating direction	0 – Increasing/increasing	0 – Increasing/increasing I – Increasing/decreasing	
F 05 – Current input	0 – Passive	0 – Passive I – Active	
F 06 – Function of current input	0 – Actual value	0 – Actual value I – Set point	
F 07 – Measuring range of current input	0 – 0 to 20 mA	0 – 0 to 20 mA I – 4 to 20 mA	
F 08 – Function of binary input	0 – End maintain temperature	0 – End maintain temp. I – Switchover set points	
F 09 – Maintaining exchanger at constant heat	0 – Time adjustable	0 – Time adjustable I – Continuous	
F 10 – Upper limit value GWH	0 – No limitation	0 – No limitation I – GWH sets Y to 0 %	
F 11 – Lower limit value GWL	0 – No frost protection	0 – No frost protection I – GWL starts frost protection	
Firmware version 2.0x			
F 13 – Function of switching output	0 – Pump control	0 – Pump control I – Fault indication	
F 14 – Pump control	0 – Circulation (DHW circuit)	0 – Circul. pump (DHW) I – Circulation pump (heating circuit)	

Configuration	Default setting	Setting range	Customer data
F 15 – Switching output	0 – Passive	0 – Passive 1 – Active	
Firmware version 2.1x			
F 16 – Function of switching output	1 – Passive	1 – Passive 2 – Fault indication 3 – Circulation pump (DHW circuit) 4 – Circulation pump (heating circuit) 5 – Tapping	

Parameter	Default setting	Setting range	Customer data
P 01 – Set point W1	60.0 °C	0.0 to 100.0 °C	
P 02 – Set point W2	70.0 °C	0.0 to 100.0 °C	
P 03 – Lower measuring range value Xmin	0.0 °C	-50.0 to 90.0 °C	
P 04 – Upper measuring range value Xmax	100.0 °C	10.0 to 150.0 °C	
P 05 – Upper limit value GWH	95.0 °C	0.0 to 100.0 °C	
P 06 – Lower limit value GWL	5.0 °C	0.0 to 20.0 °C	
P 07 – Proportional gain Kp	0.8	0.1 to 50.0	
P 08 – Reset time Tn	15 s	0 to 999 s	
P 09 – Derivative-action time Tv	0 s	0 to 999 s	
P 10 – Actuator transit time Ty	25 s	10 to 240 s	
P 11 – Set-back difference	8 K	0 to 30 K	
P 12 – Heating period for heat exchanger	24 h	0 to 48 h	

Index

A

- Accessories 6, 38
 - dimensions 16 - 17
 - technical data 7
 - wiring 13 - 14
- Actual value 18 - 19
- Actuator stem 5, 18 - 19, 32
- Adaptation 18

B

- Blinking pattern
 - red LED 9 - 10
 - yellow LED 8

C

- Circulation pump 18, 20 - 21
- Command mode 44
- Command pen 44
- Communication port 38
- Configuration
 - functions 28
 - parameters 29
- Configuration list 48 - 49
- Connection to valve 11
- Copy function (memory pen) 44
- Current input 18 - 19
- Customer data 48 - 49

D

- Data logging 45
- Data transmission 38 - 47
 - accessories 38
 - offline mode 24, 38
 - online mode 24, 38, 40
 - with memory pen 41 - 42, 44, 46
- Diagnostics 31, 35
- Dimensions 16 - 17

E

- Electrical connection 12 - 15
- Errors 26, 31
 - EEPROM 9
 - flow rate exceeds measuring range . . 10
 - limit switch 9
 - memory pen
 - EEPROM 9
 - validity 8
 - temperature too high 9
 - wire breakage
 - at current input 10
 - at temperature input 10
- Excessive temperature protection . . . 18, 20

F

- Fault indication 18, 20 - 21
- Flow rate sensor 7, 14 - 15, 18
- Flow switch 5, 13, 18
- Frost protection 18, 20

H

- Handwheel 5 - 6, 11, 32
- Hardware package 38

I

- Information 31

L

- LED 10, 41

M

- Manual level 32
- Memory pen 38, 45 - 46
 - command mode 44
 - copy function 44
 - data download to
 - actuator 43

digital controller 43
TROVIS-VIEW 42
data logging 45 - 46
data upload from
actuator 43
TROVIS-VIEW 42
Mounting position 11

O

Offline mode. 24, 26, 38
Online mode. 24, 30, 38
Operating direction 18 - 19
Operating status 24, 26
Operating values. 30
Operational data graphs 36

P

Parameter settings 29
Principle of operation 5 - 10
Pump control 18, 20 - 21

S

Sensor pocket 16 - 17
Serial interface 5, 38
Set point 18 - 19
Statistics 34
Status messages 33
Switching output 5, 18, 20 - 21

T

Tapping. 18, 20 - 21
Tapping recognition 18, 48
Trend Viewer 36
TROVIS-VIEW
icons. 27
installation. 23
operation 26 - 31
start and settings 24
system requirements. 22

U

User level 24, 26

W

Wire breakage 10, 12



SAMSON AG · MESS- UND REGELTECHNIK
Weismüllerstraße 3 · 60314 Frankfurt am Main · Germany
Phone: +49 69 4009-0 · Fax: +49 69 4009-1507
Internet: <http://www.samson.de>

EB 5757 EN

2013-06